

02

BOILING FLASKS AND GENERAL LABORATORY GLASSWARE

BOILING FLASKS AND GENERAL LABORATORY GLASSWARE

DURAN® laboratory glassware, including heating vessels, has very good thermal-shock resistance ($\Delta T=100$ K) and a high operating temperature (+ 500 °C). Not only the glass type, but also its uniform wall thickness distribution are critical in preventing uneven expansion and stressing of the glass which could result in failure. For this reason, wall thickness distribution is, as a vital quality characteristic, continuously checked during the production process.

The beakers are primarily used as heating vessels. The tall shape is particularly suited to heating in liquid baths where the beaker contents are protected against the surrounding medium.

Erlenmeyer flasks are well suitable for mixing, because of their conical shape.

Weighing bottles are used when accurately weighing out substances. Close fitting lids with moulded grips are used to prevent the substances from being lost, e.g. during transport within the laboratory.

Watch glass dishes can be used both for covering beakers and Erlenmeyer flasks as well as for weighing small quantities of substances.

Our product range also includes a wide range of test tubes. In addition to DURAN® glass, other glass types are available (FIOLAX®, soda-lime). The characteristics of each glass type may be found in the chapter technical information.

Usage tips:

- Due to the uniform wall thickness distribution suitable for very high temperature changes.
- The printed scale on many items of DURAN® laboratory glassware is indicated with an accuracy of $\pm 10\%$. Therefore the items are not suitable for use as volumetric glassware.
- The products are not designed for use under differential pressure or vacuum conditions.

DURAN® beakers and Erlenmeyer flasks are provided with a retrace code. Using the eight-character code and the corresponding article number, a batch and quality certificate can be obtained at www.DWK-LifeSciences.com abrufen.

02



> Find your nearest **distributor** on our global network:
www.DWK-LifeSciences.com/DURAN/distributors

The DURAN® SUPER DUTY products are characterized by a higher mechanical strength achieved by reinforcing the rim. As a result of this modification, the impact strength is improved, and the risk of accidental breakage is significantly reduced.

Application note: To avoid breakages due to thermal stress, uniform and slow heating of SUPER DUTY products is recommended.

Cat. No.	Capacity (mL)	d (OD) (mm)	h (mm)	Pack Unit
21 107 29 09	150	60	80	10
21 107 36 05	250	70	95	10
21 107 41 04	400	80	110	10
21 107 48 07	600	90	125	10
21 107 54 09	1000	105	145	10
21 107 63 02	2000	132	185	10
21 107 73 07	5000	170	270	1

DURAN® SUPER DUTY Beaker

low form, with spout, with reinforced rim

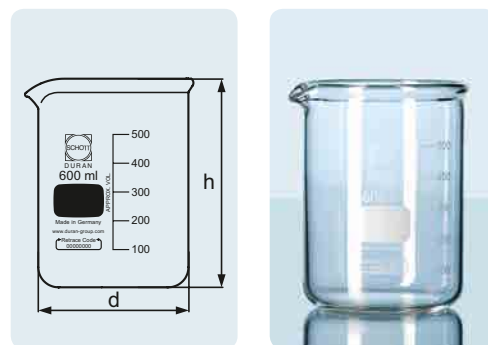

The DURAN® SUPER DUTY products are characterized by a higher mechanical strength achieved by reinforcing the rim. As a result of this modification, the impact strength is improved, and the risk of accidental breakage is significantly reduced.

Application note: To avoid breakages due to thermal stress, uniform and slow heating of SUPER DUTY products is recommended.

Cat. No.	Capacity (mL)	d (OD) (mm)	h (mm)	Pack Unit
21 118 29 08	150	54	95	10
21 118 36 04	250	60	120	10
21 118 48 06	600	80	150	10

DURAN® SUPER DUTY Beaker

high form, with spout, with reinforced rim

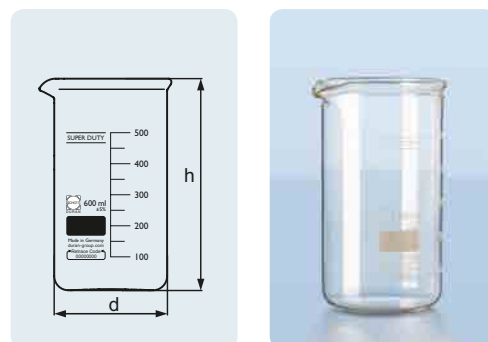

02 BOILING FLASKS AND GENERAL LABORATORY GLASSWARE

DURAN® SUPER DUTY Erlenmeyer Flask

narrow neck, with reinforced rim

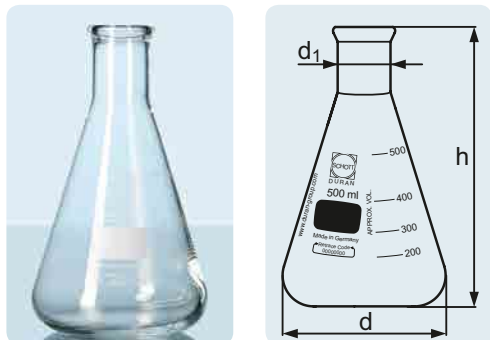

The DURAN® SUPER DUTY products are characterized by a higher mechanical strength achieved by reinforcing the rim. As a result of this modification, the impact strength is improved, and the risk of accidental breakage is significantly reduced.

Application note: To avoid breakages due to thermal stress, uniform and slow heating of SUPER DUTY products is recommended.

Cat. No.	Capacity (mL)	d (OD) (mm)	d ₁ (OD) (mm)	h (mm)	Pack Unit
21 217 14 08	25	42	22	75	10
21 217 17 08	50	51	22	90	10
21 217 24 04	100	64	22	105	10
21 217 36 06	250	85	34	145	10
21 217 44 05	500	105	34	180	10
21 217 54 01	1 000	131	42	220	10
21 217 63 03	2 000	166	50	280	10
21 217 73 08	5 000	220	52	365	1

DURAN® SUPER DUTY Erlenmeyer Flask

wide neck, with reinforced rim

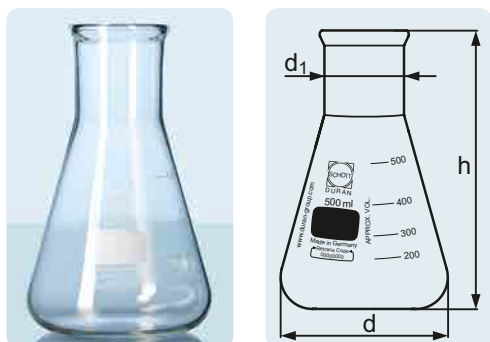

The DURAN® SUPER DUTY products are characterized by a higher mechanical strength achieved by reinforcing the rim. As a result of this modification, the impact strength is improved, and the risk of accidental breakage is significantly reduced.

Application note: To avoid breakages due to thermal stress, uniform and slow heating of SUPER DUTY products is recommended.

Cat. No.	Capacity (mL)	d (OD) (mm)	d ₁ (OD) (mm)	h (mm)	Pack Unit
21 227 24 02	100	64	34	105	10
21 227 36 04	250	85	50	140	10
21 227 44 03	500	105	50	175	10
21 227 54 08	1 000	131	50	220	10

The DURAN® SUPER DUTY products are characterized by a higher mechanical strength achieved by reinforcing the rim. As a result of this modification, the impact strength is improved, and the risk of accidental breakage is significantly reduced.

Application note: To avoid breakages due to thermal stress, uniform and slow heating of SUPER DUTY products is recommended.

Cat. No.	Capacity (mL)	d (OD) (mm)	h (mm)	Accuracy limits (mL)	Graduation (mL)	Pack Unit
21 394 24 06	100	39	168	1	2	2
21 394 36 08	250	54	205	2	5	2
21 394 44 07	500	66	253	5	10	2
21 394 54 03	1 000	85	290	10	20	2

DURAN® SUPER DUTY Measuring Cylinder

low form, class B, with graduation and hexagonal base

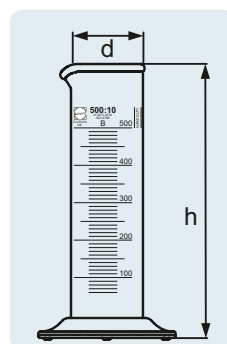

ISO
4788

A
121 °C

With easy-to-read scale and large labelling field for easy marking in fired-on, highly durable, white ceramic. Spout for clean pouring. Uniform wall thickness distribution makes these beakers ideal for heating applications.

Cat. No.	Capacity (mL)	d (OD) (mm)	h (mm)	Remark	Pack Unit
21 106 07 01	5	22	30	Without graduation.Without Retrace Code.	10
21 106 08 04	10	26	35	Without graduation.Without Retrace Code.	10
21 106 14 06	25	34	50		10
21 106 17 06	50	42	60		10
21 106 24 02	100	50	70		10
21 106 29 08	150	60	80		10
21 106 36 04	250	70	95		10
21 106 41 03	400	80	110		10
21 106 48 06	600	90	125		10
21 106 53 05	800	100	135		10
21 106 54 08	1 000	105	145		10
21 106 63 01	2 000	132	185		10
21 106 68 07	3 000	152	210		4
21 106 73 06	5 000	170	270		1
21 106 86 02	10 000	217	350	Non-DIN/ISO size.	1

DURAN® Beaker

low form, with spout

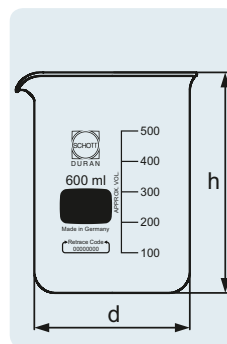

ISO
3819

Retrace Code

A
121 °C

02 BOILING FLASKS AND GENERAL LABORATORY GLASSWARE

DURAN® Beaker

high form, with spout

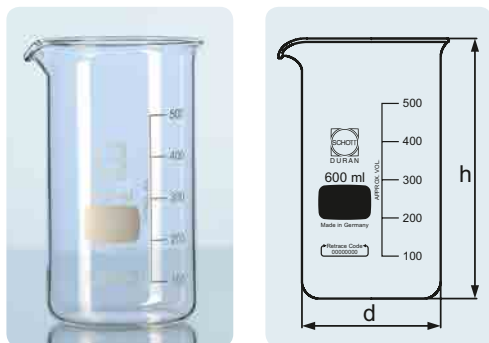

With easy-to-read scale and large labelling field for easy marking in fired-on, highly durable, white ceramic. With spout for clean pouring. Uniform wall thickness distribution makes these beakers ideal for heating applications.

Cat. No.	Capacity (mL)	d (OD) (mm)	h (mm)	Pack Unit
21 116 17 04	50	38	70	10
21 116 24 09	100	48	80	10
21 116 29 06	150	54	95	10
21 116 36 02	250	60	120	10
21 116 41 01	400	70	130	10
21 116 48 04	600	80	150	10
21 116 53 03	800	90	175	10
21 116 54 06	1 000	95	180	10
21 116 63 08	2 000	120	240	10
21 116 68 05	3 000	135	280	2

DURAN® Beaker

high form, without spout

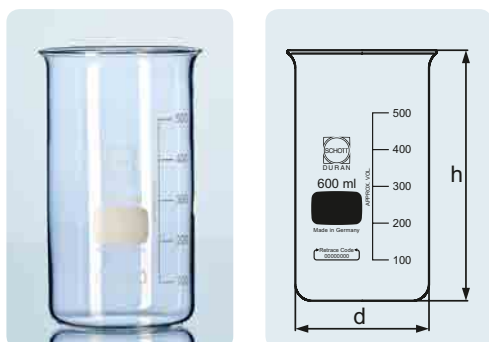

With easy-to-read scale and large labelling field for easy marking in fired-on, highly durable, white ceramic. Uniform wall thickness distribution makes these beakers ideal for heating applications.

Cat. No.	Capacity (mL)	d (OD) (mm)	h (mm)	Pack Unit
21 117 17 05	50	38	70	10
21 117 24 01	100	48	80	10
21 117 29 07	150	54	95	10
21 117 36 03	250	60	120	10
21 117 41 02	400	70	130	10
21 117 48 05	600	80	150	10
21 117 54 07	1 000	95	180	10

DURAN® Beaker

heavy-wall (filtering beaker)

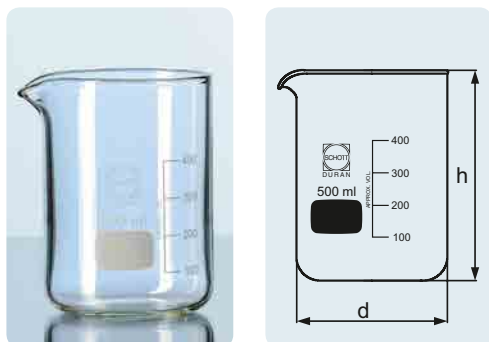

With easy-to-read scale and large labelling field for easy marking in fired-on, highly durable, white ceramic. Has, due to the increased wall thickness, better mechanical properties than the standard beaker. Thermal shock resistance, however, is reduced so only limited application for heating. With spout for clean pouring.

Cat. No.	Capacity (mL)	d (OD) (mm)	h (mm)	Remark	Pack Unit
21 131 24 09	100	52	85		10
21 131 29 06	150	54	93		10
21 131 36 02	250	70	94		10
21 131 44 01	500	89	124		10
21 131 54 06	1 000	105	160		10
21 131 63 08	2 000	135	195		10
21 131 68 05	3 000	157	205		4
21 131 73 04	5 000	182	256		1
21 131 86 09	10 000	225	340	Without graduation.	1
21 131 88 06	15 000	260	390	Without graduation.	1
21 131 91 08	20 000	285	430	Without graduation.	1

Spout for clean pouring.

Cat. No.	Capacity (mL)	d (OD) (mm)	h (mm)	Pack Unit
21 141 29 04	150	59	87	10
21 141 36 09	250	68	105	10
21 141 44 08	500	86	142	10

DURAN® Philips Beaker

with spout

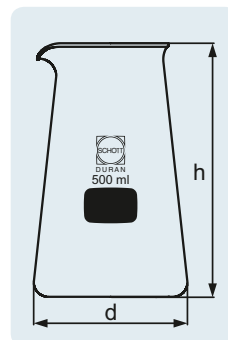

Cat. No.	Capacity (mL)	d (OD) (mm)	h (mm)	Pack Unit
21 126 01 06	100	50	78	10

DURAN® Berzelius Beaker

without spout

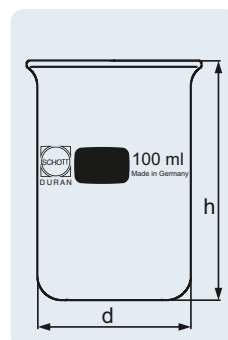

Manufactured according to DIN ISO 9665.

Cat. No.	d _i (ID) (mm)	h (mm)	Pack Unit
21 125 01 05	59	85	10

DURAN® Bloom Test Vessel

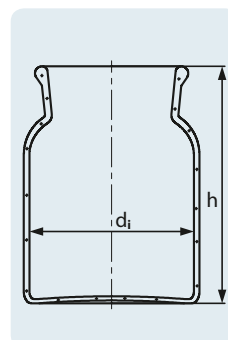

DURAN® Erlenmeyer Flask

narrow neck

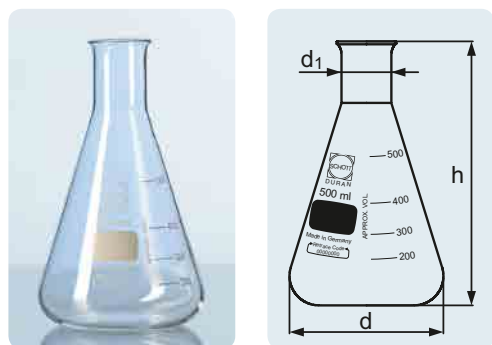

DIN ISO
1773

A
121 °C

Retrace
Code

USP
Standard

With easy-to-read scale and large labelling field for easy marking in fired-on, highly durable, white ceramic. Due to conical form, suited to the mixing of liquids. Uniform wall thickness distribution makes these flasks ideal for heating applications.

Cat. No.	Capacity (mL)	d (OD) (mm)	d ₁ (OD) (mm)	h (mm)	Remark	Pack Unit
21 216 14 07	25	42	22	75	Without Retrace Code.	10
21 216 17 07	50	51	22	90		10
21 216 24 03	100	64	22	105		10
21 216 28 06	125	67	28	112		10
21 990 27 02	150	74	28	118	Non-DIN ISO size.	10
21 216 32 02	200	79	34	131	Non-DIN ISO size.	10
21 216 36 05	250	85	34	145		10
21 216 39 05	300	87	34	156	Non-DIN ISO size.	10
21 216 44 04	500	105	34	180		10
21 216 53 06	800	120	42	200		10
21 216 54 09	1 000	131	42	220		10
21 216 63 02	2 000	166	50	280		10
21 216 68 08	3 000	187	52	310		2
21 216 73 07	5 000	220	52	365		1

DURAN® Erlenmeyer Flask

wide neck

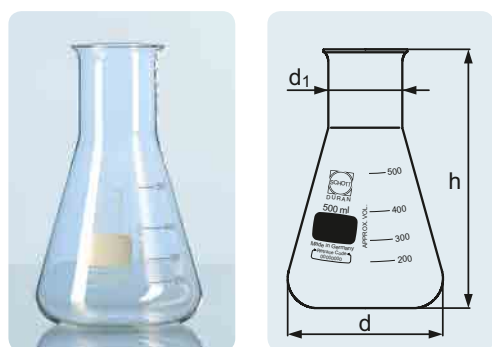

DIN ISO
24450

Retrace
Code

A
121 °C

USP
Standard

With easy-to-read scale and large labelling field for easy marking in fired-on, highly durable, white ceramic. Due to conical form, suited to the mixing of liquids. Uniform wall thickness distribution makes these flasks ideal for heating applications. The wide neck enables easy filling and cleaning.

Cat. No.	Capacity (mL)	d (OD) (mm)	d ₁ (OD) (mm)	h (mm)	Remark	Pack Unit
21 226 14 05	25	43	31	70	Non-DIN EN ISO size.	10
21 226 17 05	50	51	34	85		10
21 226 24 01	100	64	34	105		10
21 226 32 09	200	79	50	131	Non-DIN EN ISO size.	10
21 226 36 03	250	85	50	140		10
21 226 39 03	300	87	50	156	Non-DIN EN ISO size.	10
21 226 44 02	500	105	50	175		10
21 226 54 07	1 000	131	50	220		10
21 226 63 09	2 000	153	72	276	Non-DIN EN ISO size.	10

With easy-to-read scale and large labelling field for easy marking in fired-on, highly durable, white ceramic. The flask can be closed with a PBT cap or membrane cap (permits gas exchange).

Typical applications: The flask is suitable for storage, media preparation and cultivation.

Cat. No.	Capacity (mL)	d (OD) (mm)	h (mm)	DIN Thread (GL)	Pack Unit
with PBT cap					
21 803 24 51	100	64	109	25	10
21 803 36 53	250	85	149	32	10
21 803 44 52	500	105	180	32	10
21 803 54 57	1000	131	225	32	10
without screw cap					
21 803 24 02	100	64	105	25	10
21 803 36 04	250	85	145	32	10
21 803 44 03	500	105	175	32	10
21 803 54 08	1000	131	220	32	10

DURAN® Erlenmeyer Flask

with DIN thread

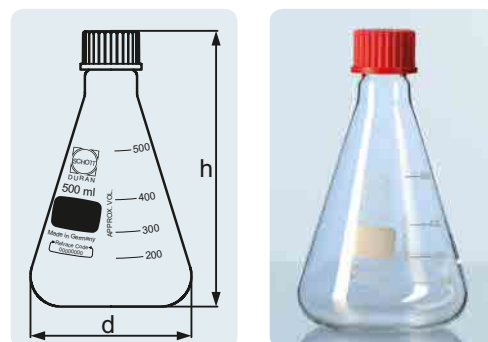

With easy-to-read scale and large labelling field for easy marking in fired-on, highly durable, white ceramic. The flask can be closed with a glass stopper.

Typical applications: the iodine flask is suitable for determining the iodine number, i.e. the content of unsaturated fatty acids in oils and fats.

Cat. No.	Capacity (mL)	d (OD) (mm)	h (mm)	Neck	Pack Unit
24 192 27 04	100	64	120	29/32	10
24 192 37 09	250	85	160	29/32	10
24 192 46 02	500	105	195	29/32	10
24 192 56 07	1000	131	235	29/32	10

DURAN® Iodine Flask

Erlenmeyer shape, with standard ground joint and glass stopper

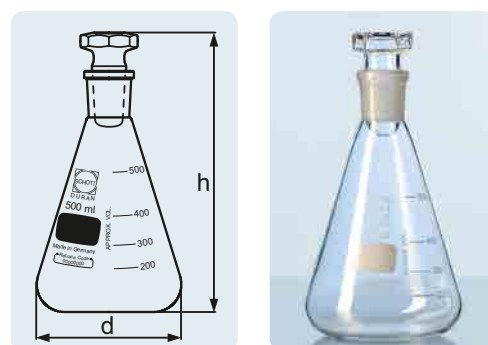

Cat. No.	Capacity (mL)	d (OD) (mm)	d ₁ (OD) (mm)	h (mm)	Remark	Pack Unit
21 227 68 07	3000	190	106	285	Without graduation.	1
21 227 73 06	5000	220	108	322	Without graduation.	1
21 227 86 02	10000	285	147	420	Without graduation.	1

DURAN® Conical Flask

Erlenmeyer shape, wide neck

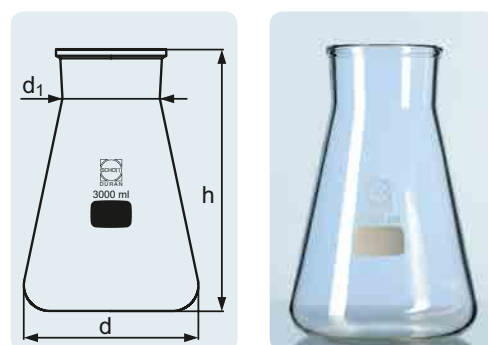

02 BOILING FLASKS AND GENERAL LABORATORY GLASSWARE

DURAN® Round Bottom Flask Narrow Neck

with beaded rim

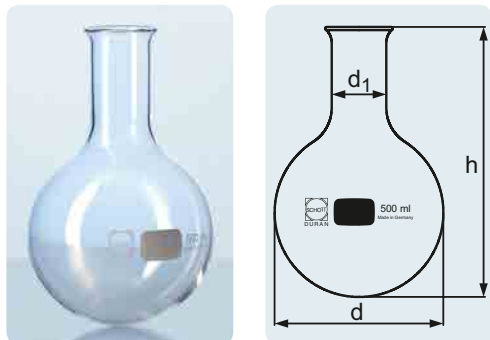

DIN ISO
1773

A
121 °C

USP
Standard

Uniform wall thickness distribution makes these flasks ideal for heating applications. The geometry permits very uniform heating. Flasks with a neck diameter of 65 mm or more have a reinforced rim.

Cat. No.	Capacity (mL)	d (OD) (mm)	d ₁ (OD) (mm)	h (mm)	Remark	Pack Unit
21 721 17 06	50	51	26	95		10
21 721 24 02	100	64	26	110		10
21 721 36 04	250	85	34	144		10
21 721 44 03	500	105	34	168		10
21 721 54 08	1 000	131	42	200		10
21 721 64 04	2 000	166	42	250	Non-DIN ISO size.	10
21 721 68 07	3 000	185	50	260	Non-DIN ISO size.	1
21 721 71 09	4 000	207	52	290		1
21 721 73 06	5 000	223	50	305	Non-DIN ISO size.	1
21 721 77 09	6 000	236	51	355	Non-DIN ISO size.	1
21 721 86 02	10 000	279	65	380		1
21 721 87 05	12 000	295	65	380	Non-DIN ISO size. Conforms to ASTM E 1403.	1
21 721 91 01	20 000	345	76	515	Conforms to ASTM E 1403.	1

DURAN® Round Bottom Flask Wide Neck

with beaded rim

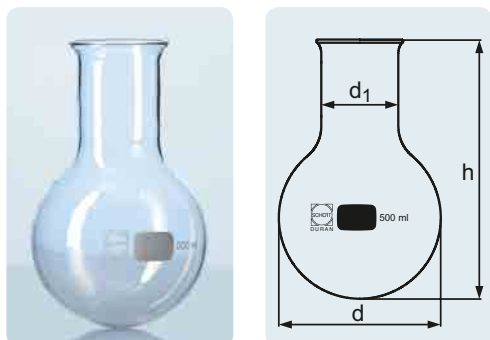

DIN ISO
24450

A
121 °C

USP
Standard

Uniform wall thickness distribution makes these flasks ideal for heating applications. The geometry permits very uniform heating. The wide neck permits easy filling and removal of flask contents. Flasks with a neck diameter of 76 mm or more have a reinforced rim.

Cat. No.	Capacity (mL)	d (OD) (mm)	d ₁ (OD) (mm)	h (mm)	Remark	Pack Unit
21 741 17 02	50	51	34	105	Non-DIN EN ISO size.	10
21 741 24 07	100	64	35	110		10
21 741 36 09	250	85	51	143		10
21 741 44 08	500	105	50	168		10
21 741 54 04	1 000	131	50	200		10
21 741 55 07	1 000	131	65	200	Non-DIN EN ISO size.	10
21 741 63 06	2 000	165	76	240		10
21 741 64 09	2 000	166	50	240	Non-DIN EN ISO size.	10
21 741 68 03	3 000	185	65	260	Non-DIN EN ISO size.	1
21 741 71 05	4 000	206	76	290		1
21 741 73 02	5 000	223	65	310	Non-DIN EN ISO size.	1
21 741 76 02	6 000	236	89	330		1
21 741 77 05	6 000	236	65	330	Non-DIN EN ISO size.	1
21 741 86 07	10 000	279	89	420	Non-DIN EN ISO size.	1
21 741 91 06	20 000	345	89	520	Non-DIN EN ISO size.	1

Uniform wall thickness distribution makes these flasks ideal for heating applications. Flat base means flasks can be set down without a supporting ring. Flasks with a neck diameter of 65 mm have a reinforced rim.

DURAN® Flat Bottom Flask Narrow Neck

with beaded rim

Cat. No.	Capacity (mL)	d (OD) (mm)	d ₁ (OD) (mm)	h (mm)	Remark	Pack Unit
21 711 17 08	50	51	26	90		10
21 711 24 04	100	64	26	105		10
21 711 36 06	250	85	34	138		10
21 711 44 05	500	105	34	163		10
21 711 54 01	1000	131	42	190		10
21 711 64 06	2000	166	42	250	Non-DIN ISO size.	10
21 711 68 09	3000	185	50	250	Non-DIN ISO size.	1
21 711 71 02	4000	207	50	275		1
21 711 73 08	5000	223	50	290	Non-DIN ISO size.	1
21 711 76 08	6000	237	65	315		1
21 711 86 04	10000	280	65	360		1

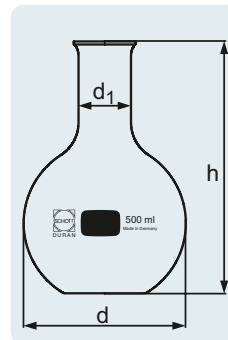

Uniform wall thickness distribution makes these flasks ideal for heating applications. Flat base means flasks can be set down without a supporting ring. The wide neck permits easy filling and removal of flask contents. Flasks with a neck diameter 76 mm have a reinforced rim.

DURAN® Flat Bottom Flask Wide Neck

with beaded rim

Cat. No.	Capacity (mL)	d (OD) (mm)	d ₁ (OD) (mm)	h (mm)	Remark	Pack Unit
21 731 17 04	50	51	34	90		10
21 731 24 09	100	64	34	105		10
21 731 36 02	250	85	50	138		10
21 731 44 01	500	105	50	163		10
21 731 54 06	1000	131	50	190		10
21 731 63 08	2000	166	76	230	Non-DIN EN ISO size.	10
21 731 64 02	2000	166	50	230		10

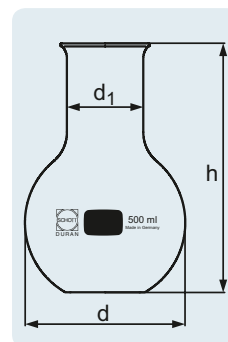

Uniform wall thickness distribution makes these flasks ideal for heating applications and distillations. DURAN® Engler Distilling Flasks comply with the requirements of ASTM D86 and DIN EN ISO 3405 for the atmospheric distillation of petroleum products.

DURAN® Engler Flask

with beaded rim, side outlet

Cat. No.	Capacity (mL)	d (OD) (mm)	d ₁ (OD) (mm)	Side arm d ₂ (OD) (mm)	Side arm l (mm)	h (mm)	Pack Unit
21 653 24 04	100	66	20	6	100	215	10
21 653 28 07	125	69	22	7	100	215	10
21 653 29 01	150	73	20	6	100	223	10
according to ASTM D86 and DIN EN ISO 3405							
21 654 28 08	125	69	22	7	100	215	2

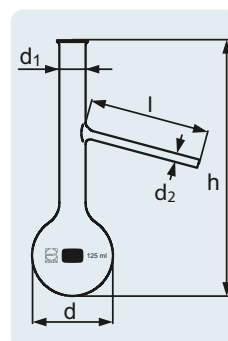

02 BOILING FLASKS AND GENERAL LABORATORY GLASSWARE

DURAN® Engler Flask

with standard ground joint 19/26,
side outlet

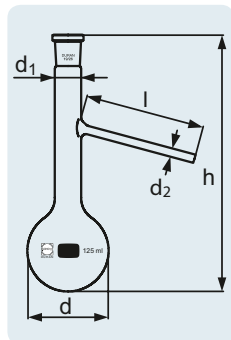

Uniform wall thickness distribution makes these flasks ideal for heating applications and distillations. DURAN® Engler Distilling Flasks comply with the requirements of ASTM D86 and DIN EN ISO 3405 for the atmospheric distillation of petroleum products.

Cat. No.	Capacity (mL)	d (OD) (mm)	d ₁ (OD) (mm)	Side arm d ₂ (OD) (mm)	Side arm l (mm)	h (mm)	Pack Unit
according to ASTM D86 and DIN EN ISO 3405							
24 654 28 05	125	69	22	7	100	215	10



Glass Ceramic Laboratory Protection Plate

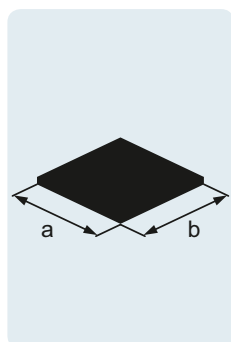
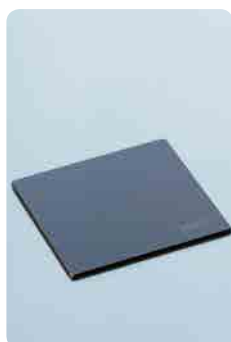

Due to low thermal expansion stresses, these glass ceramic plates are well suited to heating glassware with a Bunsen burner.

Cat. No.	Plate dimensions (a x b mm)	Pack Unit
23 821 53 09	135 x 135	10
23 821 57 03	155 x 155	10
23 821 58 06	175 x 175	10

Square Quadrupod

for glass ceramic laboratory protection plate

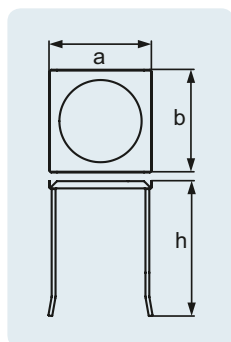

Plate holder for glass ceramic plates. Made from heat-resistant chrome-nickel steel with four legs for extra stability.

Cat. No.	h (mm)	Plate dimensions (a x b mm)	Pack Unit
29 077 53 02	210	135 x 135	5
29 077 57 05	210	155 x 155	5
29 077 58 08	220	175 x 175	5

Plate holder for glass ceramic plates. Made from heat-resistant chrome-nickel steel.

Plate Holder

for glass ceramic laboratory protection plate

Cat. No.	Plate dimensions (a x b mm)	Pack Unit
29 078 53 03	135 x 135	5
29 078 57 06	155 x 155	5
29 078 58 09	175 x 175	5

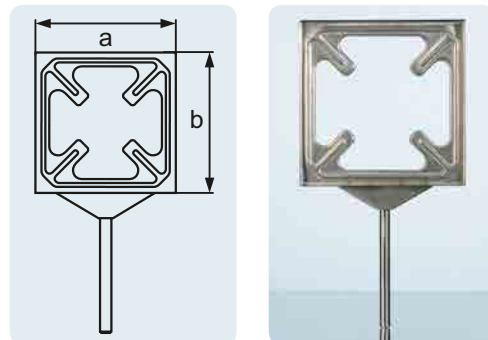

Ideal for cleaning glass ceramic plates.

Cleaning Scraper

for glass ceramic laboratory protection plate

Cat. No.	Pack Unit
29 079 01 09	10

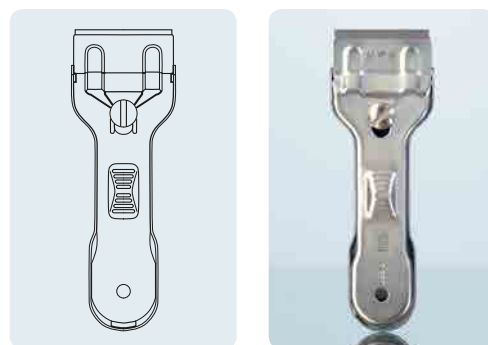

Cat. No.	Capacity (mL)	d (OD) (mm)	h (mm)	Pack Unit
without socket and wick				
23 400 24 06	100	75	103	10
with socket and wick				
23 400 24 55	100	75	103	10
Accessories for spirit lamp: wicks for spirit lamps				
29 402 00 07				50
Accessories for spirit lamp: sockets for spirit lamps (of aluminium)				
29 403 00 08				50

Spirit Lamp from Soda-lime Glass

without filling tubulature, with ground over-cap

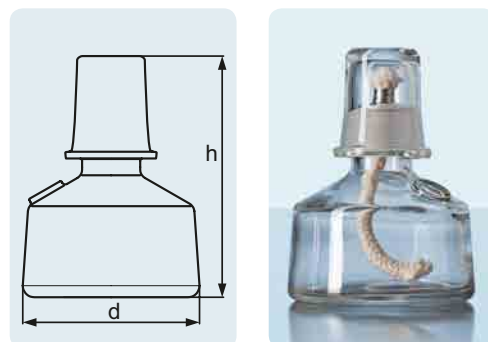

DURAN® Evaporating Dish

with spout

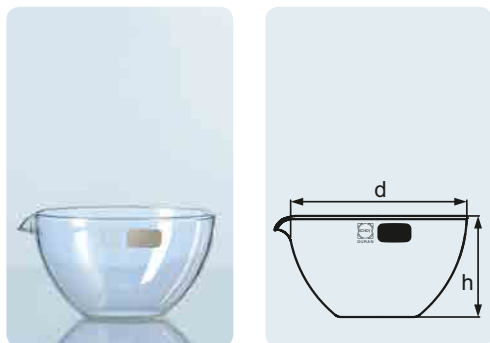

DIN
12336

A
121 °C

Cat. No.	Capacity (mL)	d (OD) (mm)	h (mm)	Remark	Pack Unit
21 301 32 02	15	50	25	Without labelling field.	10
21 301 34 08	45	60	30	Without labelling field.	10
21 301 38 02	60	70	35	Without labelling field.	10
21 301 41 04	90	80	45	Without labelling field.	10
21 301 44 04	170	95	55		10
21 301 49 01	320	115	65		10
21 301 54 09	600	140	80		10
21 301 59 06	1 500	190	100		10
21 301 63 02	2 500	230	130		10

DURAN® Crystallizing Dish

with and without spout

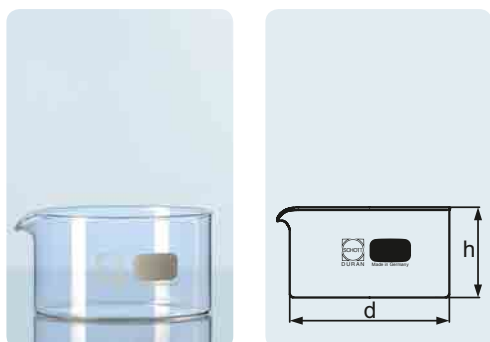

DIN
12337

DIN
12338

A
121 °C

Cat. No.	Capacity (mL)	d (OD) (mm)	h (mm)	Pack Unit
with spout, DIN 12 338				
21 311 24 01	20	40	25	10
21 311 32 09	40	50	30	10
21 311 34 06	60	60	35	10
21 311 38 09	100	70	40	10
21 311 41 02	150	80	45	10
21 311 44 02	300	95	55	10
21 311 49 08	500	115	65	10
21 311 54 07	900	140	75	10
21 311 59 04	2 000	190	90	10
21 311 63 09	3 500	230	100	10
without spout, DIN 12 337				
21 313 24 03	20	40	25	10
21 313 32 02	40	50	30	10
21 313 34 08	60	60	35	10
21 313 38 02	100	70	40	10
21 313 41 04	150	80	45	10
21 313 44 04	300	95	55	10
21 313 49 01	500	115	65	10
21 313 54 09	900	140	75	10
21 313 59 06	2 000	190	90	10
21 313 63 02	3 500	230	100	10

Close-fitting lid prevents any sample loss during transport after weighing. Available in low and high forms.

DURAN® Weighing Bottle

with ground lid

Cat. No.	Capacity (mL)	d (OD) (mm)	h (mm)	Pack Unit
Low form				
24 210 13 04	5	28	25	10
24 210 23 09	15	38	30	10
24 210 32 02	30	54	30	10
24 210 41 04	80	85	30	10
High form				
24 211 13 05	10	28	40	10
24 211 18 02	20	32	50	10
24 211 23 01	45	38	70	10
24 211 24 04	70	44	80	10

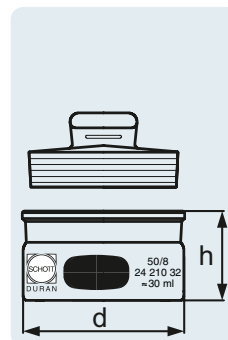

Available in DURAN® and also in soda-lime glass.

DURAN® Watch Glass Dish

fused rim

Cat. No.	d (OD) (mm)	Pack Unit
DURAN®		
21 321 24 08	40	10
21 321 32 07	50	10
21 321 34 04	60	10
21 321 41 09	80	10
21 321 46 06	100	10
21 321 52 08	125	10
21 321 57 05	150	10
21 321 61 01	200	10
21 321 66 07	250	1
Soda-lime glass		
23 321 24 09	40	10
23 321 32 08	50	10
23 321 34 05	60	10
23 321 38 08	70	10
23 321 41 01	80	10
23 321 43 07	90	10
23 321 46 07	100	10
23 321 51 06	120	10
23 321 52 09	125	10
23 321 57 06	150	10
23 321 61 02	200	10
23 321 66 08	250	10

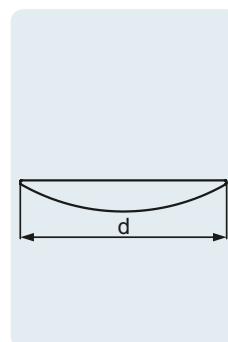

02 BOILING FLASKS AND GENERAL LABORATORY GLASSWARE

DURAN® Organ Storage Jar

without stopper

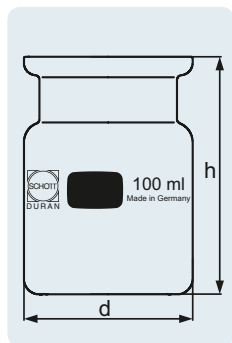

Cat. No.	Capacity (mL)	d (OD) (mm)	h (mm)	Pack Unit
24 204 23 06	75	50	70	10
24 204 24 09	100	54	75	10

DURAN® Jar

with lid

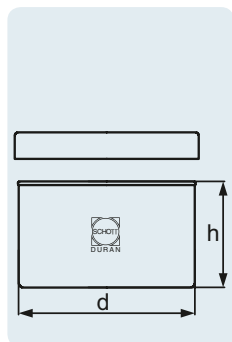

Cat. No.	d (OD) (mm)	h (mm)	Volume approx. (mL)	Pack Unit
24 208 34 09	60	40	75	10
24 208 41 05	80	50	175	10
24 208 45 08	100	60	325	10
24 208 57 01	150	80	1000	10

DURAN® Jar

with shoulder and lid

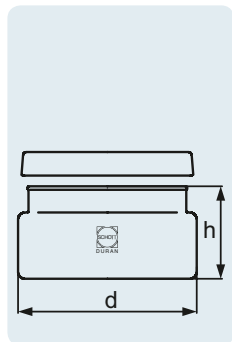

Cat. No.	d (OD) (mm)	h (mm)	Volume approx. (mL)	Pack Unit
24 207 34 08	60	35	70	10
24 207 45 07	103	55	250	10
24 207 51 09	121	64	500	10

Cat. No.	d (OD) (mm)	h (mm)	Volume approx. (mL)	Pack Unit
24 205 01 09	80	80	250	10
24 205 03 06	100	100	500	10
24 205 05 03	120	120	1000	1
24 205 10 02	150	150	2000	1
24 205 21 01	210	210	6000	1
24 205 32 09	260	260	12000	1

DURAN® Cylinder

with knobbed lid, polished rim

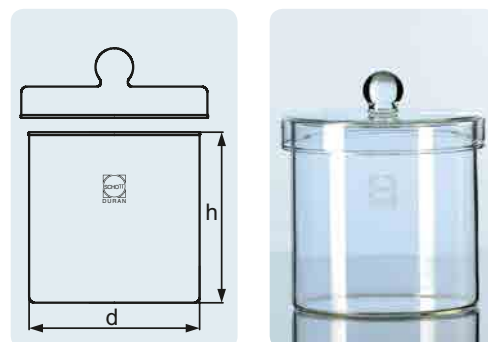

Cat. No.	Capacity (mL)	d (OD) (mm)	h (mm)	h ₁ (mm)	Neck	Pack Unit
21 580 24 01	100	52	135	39	NS 34.5	10
21 580 39 03	300	69	163	48	NS 45	10
21 580 48 05	600	81	214	50	NS 50	10
21 580 51 07	750	90	240	57	NS 60	10
21 580 58 01	1 200	100	253	57	NS 60	10

DURAN® Specimen Jar

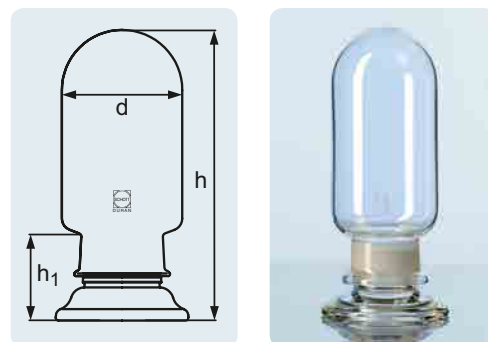

The precise grinding of the knobbed lid and base vessel enables a very tight seal.

DURAN® Specimen Jar

with ground, knobbed lid

Cat. No.	d (OD) (mm)	h (mm)	Volume approx. (mL)	Pack Unit
24 209 02 07	65	63	80	10
24 209 09 01	65	103	175	10
24 209 11 09	115	103	460	10
24 209 16 06	90	123	395	10
24 209 17 09	132	123	875	1
24 209 24 05	90	153	530	1
24 209 26 02	115	153	890	1
24 209 28 08	162	153	1875	1
24 209 38 04	115	203	1150	1
24 209 39 07	162	203	2675	1
24 209 49 03	115	253	1575	1
24 209 50 08	162	253	3475	1
24 209 57 02	132	303	2400	1
24 209 59 08	268	303	11250	1

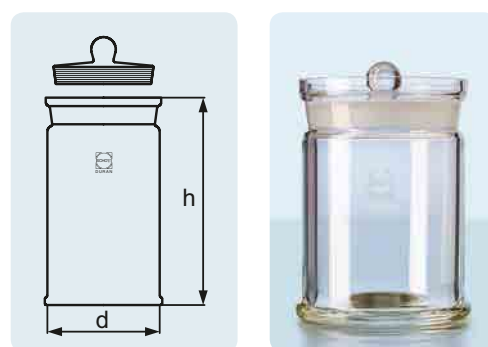

02 BOILING FLASKS AND GENERAL LABORATORY GLASSWARE

DURAN® Museum Jar

with ground glass plate

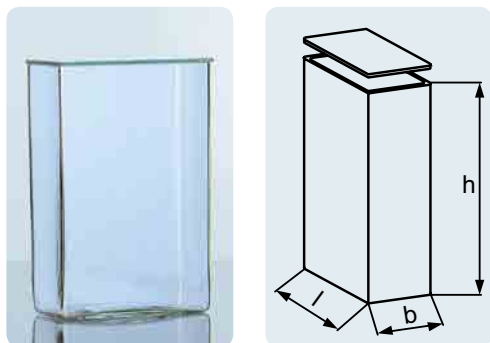

The precise grinding of the glass plate and base vessel enables a very tight seal.

Cat. No.	h (mm)	l (mm)	b (mm)	Pack Unit
21 363 05 04	100	60	50	10
21 363 11 06	120	100	50	1
21 363 13 03	130	130	50	1
21 363 19 03	150	150	50	1
21 363 28 05	180	120	60	1
21 363 47 03	210	210	100	1
21 363 58 02	250	250	140	1

DURAN® Multi-purpose Cylinder

with round base, without graduation

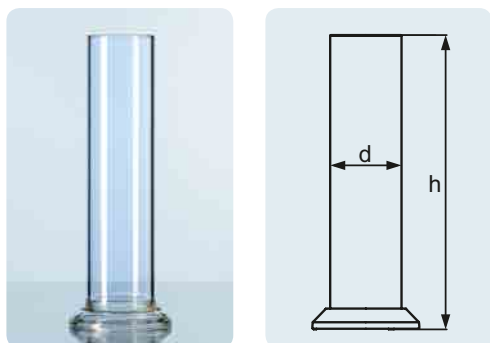

Rough ground rim.

Cat. No.	d (OD) (mm)	h (mm)	Volume approx. (mL)	Pack Unit
21 398 21 01	50	150	220	10
21 398 34 06	40	200	180	10
21 398 36 03	60	200	420	10
21 398 46 08	60	250	530	10
21 398 52 01	40	300	280	10
21 398 53 04	50	300	450	10
21 398 68 06	40	400	380	10
21 398 74 08	80	400	1650	10
21 398 77 08	65	450	1250	10
21 398 80 01	50	500	770	10

A
121 °C

DURAN® Standing Cylinder

with round base, without graduation

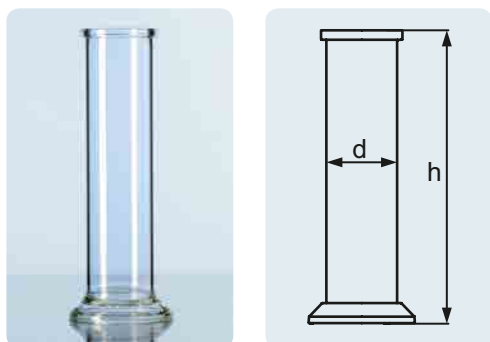

Plane ground rim.

Cat. No.	d (OD) (mm)	h (mm)	Volume approx. (mL)	Pack Unit
21 399 07 01	40	100	80	10
21 399 34 07	40	200	190	10
21 399 36 04	60	200	440	10
21 399 46 09	60	250	550	10
21 399 68 07	40	400	390	10

A
121 °C

Wall thickness and geometry designed to suit vacuum applications.

Cat. No.	d (OD) (mm)	h (mm)	h ₁ (mm)	Pack Unit
24 460 59 02	185	250	50	1
24 460 66 07	260	255	50	1
24 460 69 07	315	300	50	1

DURAN® Bell Jar

with glass knob top

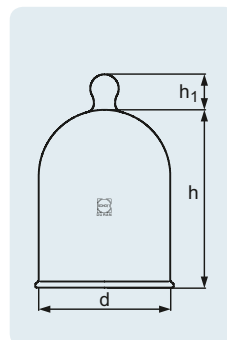

Wall thickness and geometry designed to suit vacuum applications. Neck aperture, standard ground joint NS 34/35.

Cat. No.	d (OD) (mm)	h (mm)	h ₁ (mm)	Neck	Pack Unit
24 465 59 07	185	250	50	34/35	1
24 465 61 06	215	300	50	34/35	1
24 465 69 03	315	500	50	34/35	1

DURAN® Bell Jar

with aperture in neck, open topped

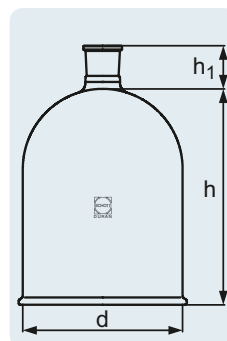

For scale divisions and accuracy limits, see table.

Cat. No.	Capacity (mL)	h (mm)	d (OD) (mm)	Pack Unit
21 401 54 03	1000	470	120	10

DURAN® Sedimentation Cone

Imhoff type, graduated

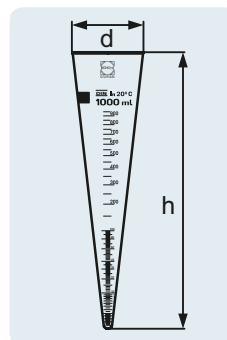

Scale (mL)	Division (mL)	Tolerance ± (mL)
0 – 2	0.1	0.1
2 – 10	0.5	0.5
10 – 40	1	1
40 – 100	2	2
1 000	Circular marking	10

DIN
12672

DURAN® Test Tube

with beaded rim or straight rim

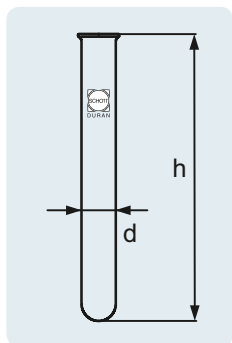
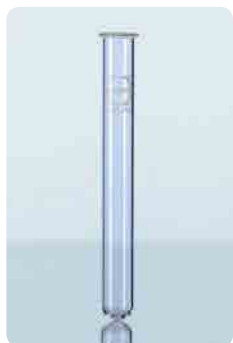

The test tubes are thick-walled and therefore mechanically very resistant, yet still retain good thermal shock resistance.

Cat. No.	d (OD) (mm)	h (mm)	Volume approx. (mL)	Wall thickness (mm)	Pack Unit
beaded rim					
26 130 01 05	8	70	2	0.8 – 1.0	100
26 130 03 02	10	75	4	0.8 – 1.0	100
26 130 06 02	10	100	5	0.8 – 1.0	100
26 130 08 08	12	75	6	0.8 – 1.0	100
26 130 11 01	12	100	8	0.8 – 1.0	100
26 130 12 04	13	100	9	0.8 – 1.0	100
26 130 13 07	14	130	16	0.8 – 1.0	100
26 130 16 07	16	130	17	1.0 – 1.2	100
26 130 21 06	16	160	21	1.0 – 1.2	100
26 130 23 03	18	180	32	1.0 – 1.2	100
26 130 26 03	20	150	34	1.0 – 1.2	100
26 130 28 09	20	180	40	1.0 – 1.2	100
26 130 33 08	25	150	55	1.0 – 1.2	50
26 130 36 08	25	200	70	1.0 – 1.2	50
26 130 38 05	30	200	100	1.0 – 1.4	50
straight rim					
26 131 01 06	8	70	2	0.8 – 1.0	100
26 131 03 03	10	75	4	0.8 – 1.0	100
26 131 06 03	10	100	5	0.8 – 1.0	100
26 131 08 09	12	75	6	0.8 – 1.0	100
26 131 11 02	12	100	8	0.8 – 1.0	100
26 131 12 05	13	100	9	0.8 – 1.0	100
26 131 13 08	14	130	16	0.8 – 1.0	100
26 131 16 08	16	130	17	1.0 – 1.2	100
26 131 21 07	16	160	21	1.0 – 1.2	100
26 131 23 04	18	180	32	1.0 – 1.2	100
26 131 26 04	20	150	34	1.0 – 1.2	100
26 131 28 01	20	180	40	1.0 – 1.2	100
26 131 33 09	25	150	55	1.0 – 1.2	50
26 131 36 09	25	200	70	1.0 – 1.2	50
26 131 38 06	30	200	100	1.0 – 1.4	50

Fiolax® Borosilicate Test Tube

with beaded rim

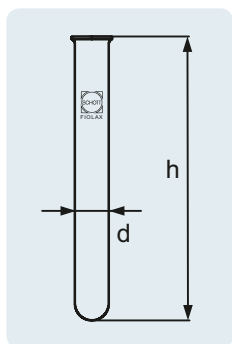

Thin-walled test tubes suited to rapid temperature changes or localized heating.

Cat. No.	d (OD) (mm)	h (mm)	Volume approx. (mL)	Wall thickness (mm)	Pack Unit
26 110 01 09	8	70	2	0.4 – 0.5	100
26 110 03 06	10	75	4	0.4 – 0.5	100
26 110 06 06	10	100	6	0.4 – 0.5	100
26 110 08 03	12	75	6,5	0.4 – 0.5	100
26 110 11 05	12	100	9	0.4 – 0.5	100
26 110 13 02	14	130	16	0.4 – 0.5	100
26 110 16 02	16	130	20	0.5 – 0.6	100
26 110 21 01	16	160	25	0.5 – 0.6	100
26 110 23 07	18	180	35	0.5 – 0.6	100
26 110 26 07	20	150	39	0.5 – 0.6	100
26 110 28 04	20	180	45	0.5 – 0.6	100
26 110 33 03	25	150	60	0.6 – 0.7	50
26 110 36 03	25	200	80	0.6 – 0.7	50
26 110 38 09	30	200	110	0.7 – 0.8	50

NMR tubes are available, according to requirement, in three accuracy classes. The correct tube can be selected depending on resonant frequency. These tubes are noteworthy for their close tolerances and accuracy, especially to their straightness, wall thickness and wall thickness distribution. Consequently, quick and accurate test results are achievable.

Cat. No.	h (mm)	OD (mm)	ID (mm)	Camber (mm)	MHZ	Pack Unit
Economic with Retrace Code						
23 170 01 17	178	4.95 ± 0.05	4.20 ± 0.05	0.07	300	250
Professional with Retrace Code						
23 170 02 11	178	4.97 ± 0.025	4.20 ± 0.025	0.03	400	250
Scientific with Retrace Code						
23 170 03 14	178	4.97 ± 0.013	4.20 ± 0.025	0,013	500	5

DURAN® NMR Tubes

three accuracy classes, with closures in mixed colours

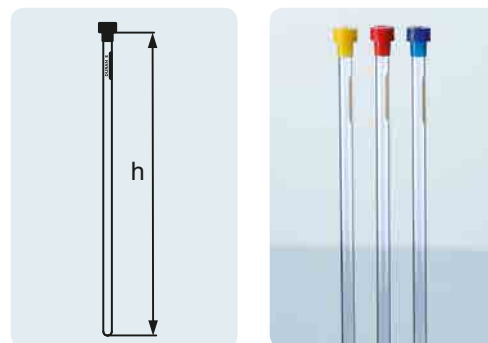

Cat. No.	Colour	Pack Unit
29 917 01 01	blue	250
29 917 02 04	red	250
29 917 03 07	yellow	250
29 917 04 01	black	250
29 917 05 04	green	250

Spare Caps for NMR Tubes

from EVA

