

05

GLASS FILTRATION
APPARATUS AND
ACCESSORIES



GLASS FILTRATION APPARATUS AND ACCESSORIES

Due to their high chemical and thermal shock resistance DURAN® filters and the corresponding filter plates are ideal for separations, e. g. with strong acids or alkalis. Thus they offer advantages in comparison with other materials such as plastic or paper. DURAN® filter products have a maximum operating temperature of +450 °C and are therefore far superior to other materials.

The corresponding filtration vessels are specially optimised to the matching filtration apparatus and are vacuum-tight due to their special geometry and high wall thickness. This characteristic has been approved by the German TÜV and marked with the "GS"-indication.

The glass filters are classified as being in porosity classes 0 to 5 according to their nominal maximum pore size. The following table shows the corresponding porosity range. The specified pore sizes always relate to the largest pore in the plate. This specification also characterises the minimum nominal size of particles which may be retained by the filtration.

Porosity table:

ISO 4793		
Porosity	Nominal max. pore size μm	Areas of application
0 P 250	160 – 250	Gas distribution
1 P 160	100 – 160	Dispersion of gas in liquids
2 P 100	40 – 100	Preparative fine filtration
3 P 40	16 – 40	Analytical filtration
4 P 16	10 – 16	Analytical fine filtration
5 P 1.6	1.0 – 1.6	Ultrafine filtration

ASTM E128-99		
Porosity	Nominal max. pore size μm	Areas of application
EC Extra Coarse	170 – 220	Gas distribution
C Coarse	40 – 60	Dispersion of gas in liquids
M Medium	10 – 16	Preparative fine filtration
F Fine	4.0 – 5.5	Analytical filtration
VF Very Fine	2.0 – 2.5	Analytical fine filtration
UF Ultra Fine	0.9 – 1.4	Ultrafine filtration

Usage tips:

- The maximum permissible operating temperature is +450 °C.
- Uniform heating is recommended to avoid thermal stresses and resultant breakages.
- Heat glass filtration apparatus with disk diameters of more than 20 mm in initially cold ovens or sterilisers only.
- The heating or cooling rate should not exceed 8 °C/min.
- When filtering hot substances observe the thermal shock resistance and, if necessary, preheat the filtration apparatus in a drying cabinet.
- Wet filtration apparatus should be heated slowly up to +80 °C and dried for one hour before increasing the temperature further.

05



> Find your nearest **distributor** on our global network:
www.DWK-LifeSciences.com/DURAN/distributors

Virtually universal applications, as the medium only comes into contact with glass and PTFE. The scaled funnel simplifies dosing and analysis. With PTFE plate holder. Filter paper, membrane filters (47 mm) or glass filters can be used for filtration. Plates and PTFE adapters are replaceable. Easy and fast cleaning. All components are available as spare parts.

Typical applications: Coarse and fine filtration, filtration of HPLC media, residue analysis.

Cat. No.	Description	Pack Unit
25 710 54 51	DURAN® filtration apparatus complete with PTFE insert and clamp (funnel 250 mL, filtering flask 1 000 mL)	1
25 710 63 04	DURAN® filtration apparatus complete with PTFE insert and clamp (funnel 500 mL, filtering flask 2 000 mL)	1
Components		
24 317 32 03	Head standard ground joint 45/40	1
29 400 28 03	PTFE adapter disc	1
29 076 36 09	Clamp (anodised aluminium)	1
24 722 36 02	Funnel with 250 mL scale	1
24 722 44 01	Funnel with 500 mL scale	1
24 202 54 04	Filtering flask with standard ground joint 45/40, 1 000 mL	1
24 202 63 06	Filtering flask with standard ground joint 45/40, 2 000 mL	1
29 255 06 03	Plastic hose connection with silicone seal, straight, GL 14	10
29 227 05 08	Screw connection caps, red, made from PBT, GL 14, 9,5 mm bore	10
25 205 02 08	DURAN® filter disc with 50 mm glass rim, por. 2	1
21 340 31 08	DURAN® slit sieve disc, diameter 48 mm	10

- ① DURAN® Filtering flask, 1 000 mL with NS 45/40
- ② Head NS 45/40 with hose connection GL 14
- ③ PTFE adapter disc
- ④ a) DURAN® Glass filter disc, 50 mm in diameter
- ④ b) DURAN® Slit-sieve disc, 48 mm in diameter
- ⑤ Funnel with 250 mL scale
- ⑥ Clamp (anodised aluminium)
- ⑦ Plastic hose connection with silicone seal, straight
- ⑧ Screw connection cap made of PBT, red, GL 14

The DURAN® PTFE Adapter combines the ground joint NS 45/40 of the filtering apparatus with the GL 45 screw thread of the DURAN® laboratory bottles. Product benefits: The adapter allows the filtrate to be directly collected in a DURAN® GL 45 laboratory bottle which reduces the risk of contamination. Note: As a vacuum is generated within the bottle during filtration, the use of DURAN® pressure plus+ bottles is highly recommended.

Cat. No.	d (OD) (mm)	d ₁ (OD) (mm)	h (mm)	Pack Unit
29 400 12 07	53	40	67	1

DURAN® Filtering Apparatus

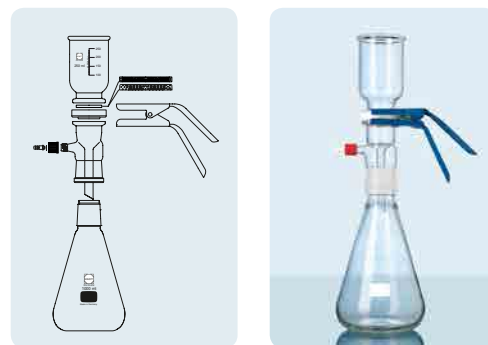

A
121 °C

Tmax.
260 °C

USP
Standard

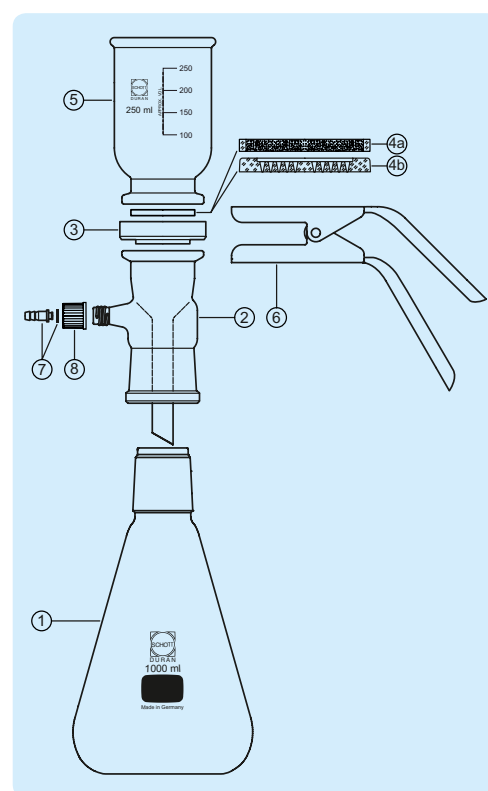

DURAN® PTFE Adapter

NS 45/40 - GL 45, with EPDM Seal

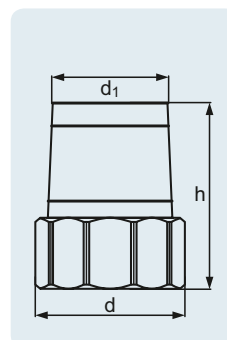

DURAN® Filter Apparatus Witt Type

Suitable for use under vacuum.

complete, with interchangeable lid, and KECK™ assembly set, standard ground joint 29/32

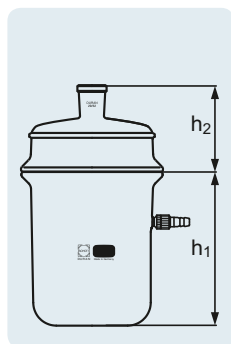

Cat. No.	h (mm)	h ₁ (mm)	DN	Socket size (NS)	Remark	Pack Unit
24 730 46 03	160	76	100	29/32	suitable lid for filter apparatus: cat. no 24 398 46 05	1
24 730 57 02	200	102	150	29/32	suitable lid for filter apparatus: cat. no 24 398 57 04	1
24 730 61 07	300	126	200	29/32	suitable lid for filter apparatus: cat. no 24 398 61 09	1



DURAN® Filter Apparatus Witt Type

Suitable for use under vacuum. Wide rough-ground tubulature.

complete, with interchangeable lid, and KECK™ assembly set, standard ground joint 45/40

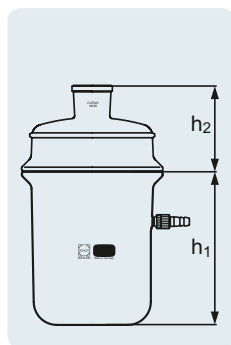

Cat. No.	h (mm)	h ₁ (mm)	DN	Socket size (NS)	Remark	Pack Unit
24 731 46 04	160	84	100	45/40	suitable lid for filter apparatus: cat. no 24 450 46 08	1
24 731 57 03	200	112	150	45/40	suitable lid for filter apparatus: cat. no 24 450 57 07	1



Cat. No.	h (mm)	Water flow rate min. (L/h)	Water pressure min. (bar)	Pack Unit
24 362 99 03	275	300	1.2	1

DURAN® Water Jet Pump

with non-return valve

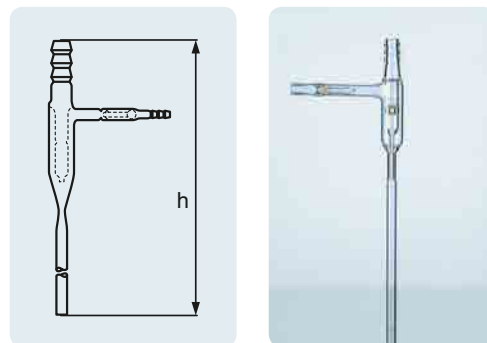

Throughput: 400 l/h at 3.5 bar water pressure und 12 °C water temperature.

Water Jet Pump

from plastic (PP), with non-return valve, hose connection and adapters for 1/2" and 3/4"

Cat. No.	h (mm)	Connection suitable for hose ID (mm)	Water flow rate min. (L/h)	Water pressure min. (bar)	Pack Unit
29 250 01 01	235	9 – 12	170	1	1

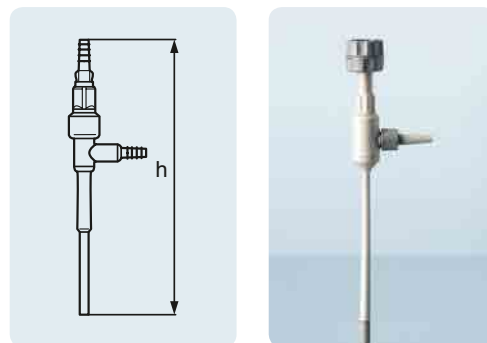

Heavy walled for vacuum use. These filtering flasks fulfil the regulations of the "equipment and product safety regulations".

DURAN® Filtering Flask with Side-Arm Socket

Typical applications: separations by vacuum filtration.

Erlenmeyer shape

Cat. No.	Capacity (mL)	d (OD) (mm)	d ₁ (OD) (mm)	h (mm)	Pack Unit
21 183 36 03	250	85	34	155	10
21 183 44 02	500	105	34	185	10
21 183 54 07	1 000	135	45	230	10
21 183 63 09	2 000	166	60	255	1

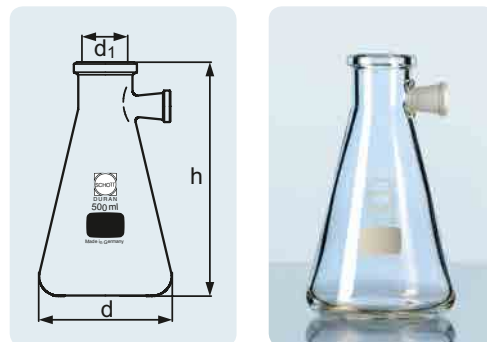

DURAN® Filtering Flask with Side-Arm Socket

bottle shape

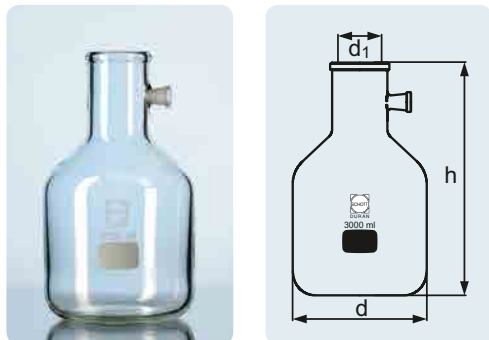

Heavy walled for vacuum use. These filtering flasks fulfil the regulations of the "equipment and product safety regulations". Provision of filtration flasks with a socket has not only made work in preparation and analytical laboratories easier and simpler, but has also reduced the risk of accidents. Note: These filtering flasks have a ground socket 17.5/26 for vacuum tube of 15 to 18mm OD (e.g. 6 x 5mm or 8 x 5mm, DIN 12 865).

Typical application: separations by vacuum filtration.

Cat. No.	Capacity (mL)	d (OD) (mm)	d ₁ (OD) (mm)	h (mm)	Pack Unit
21 193 68 04	3 000	170	58	295	1
21 193 73 03	5 000	185	68	360	1
21 193 86 08	10 000	240	70	420	1
21 193 88 05	15 000	255	70	500	1
21 193 91 07	20 000	290	70	535	1

DURAN® Filtering Flask with glass hose connection

Erlenmeyer shape

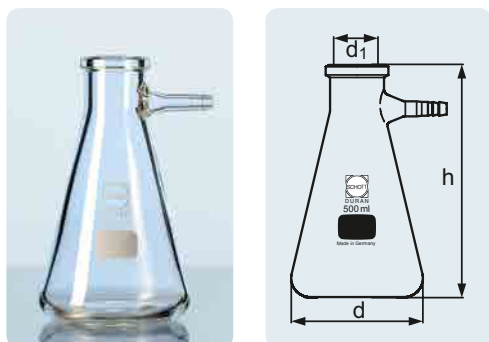

Due to the heavy wall thickness the apparatus is vacuum-tight. Does not conform to the "equipment and product safety regulations".

Typical application: separations by vacuum filtration.

Cat. No.	Capacity (mL)	d (OD) (mm)	d ₁ (OD) (mm)	h (mm)	Hose connection d (OD) (mm)	Pack Unit
21 201 24 09	100	64	24	105	11	10
21 201 36 02	250	85	34	155	11	10
21 201 44 01	500	105	34	185	11	10
21 201 54 06	1 000	135	45	230	11	10
21 201 63 08	2 000	166	60	255	11	1

Heavy walled for vacuum use. Does not conform to the "equipment and product safety regulations".

Typical application: separations by vacuum filtration.

Cat. No.	Capacity (mL)	d (OD) (mm)	d ₁ (OD) (mm)	h (mm)	Hose connection d (OD) (mm)	Pack Unit
21 191 68 02	3 000	170	58	295	11	1
21 191 73 01	5 000	185	68	360	11	1
21 191 86 06	10 000	240	70	420	11	1
21 191 88 03	15 000	255	70	500	11	1
21 191 91 05	20 000	290	70	535	11	1

DURAN® Filtering Flask with glass hose connection

bottle shape

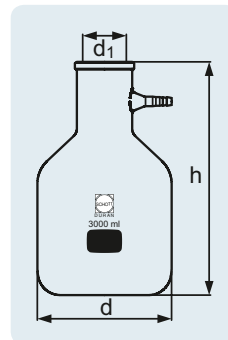

Heavy walled for vacuum use. These filtering flasks fulfil the regulations of the "equipment and product safety regulations". The plastic hose connection is replaceable.

Typical application: Separations by vacuum filtration.

Cat. No.	Capacity (mL)	d (OD) (mm)	d ₁ (OD) (mm)	h (mm)	Hose connection d (OD) (mm)	Pack Unit
21 204 24 52	100	64	24	105	9	10
21 204 36 54	250	85	34	155	9	10
21 204 44 53	500	105	34	185	9	10
21 204 54 58	1 000	135	45	230	9	10
21 204 63 51	2 000	166	60	255	9	1

DURAN® Filtering Flask with KECK™ Assembly Set

Erlenmeyer shape

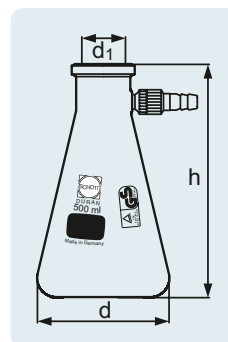

DURAN® Filtering Flask with KECK™ Assembly Set

bottle shape

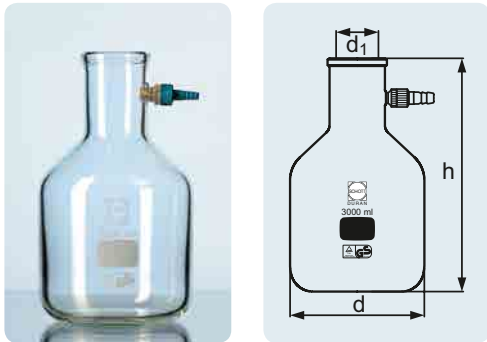

Due to the heavy wall thickness the apparatus is for vacuum use. These filtering flasks fulfil the regulations of the "equipment and product safety regulations". The plastic hose connections can be replaced.

Typical application: separations by vacuum filtration.

Cat. No.	Capacity (mL)	d (OD) (mm)	d ₁ (OD) (mm)	h (mm)	Hose connection d (OD) (mm)	Pack Unit
21 194 68 54	3 000	170	58	295	9	1
21 194 73 53	5 000	185	68	360	9	1
21 194 86 58	10 000	240	70	420	9	1
21 194 88 55	15 000	257	70	500	9	1
21 194 91 57	20 000	290	70	535	9	1



KECK™ Assembly Set

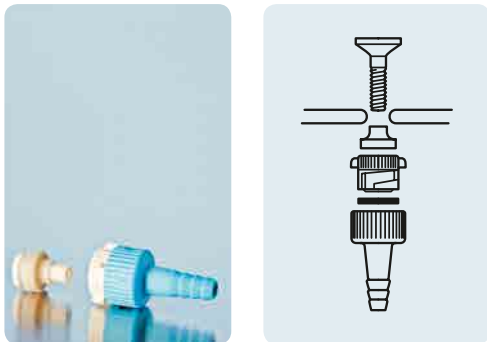

With removable plastic hose connection (PBT), short and long screw (PP), seals (VMQ, EPDM). Suitable for filtering flasks 100 – 20 000 mL.

Cat. No.	Hose connection d (OD) (mm)	Pack Unit
29 258 54 07	9	10



Rubber Conical Gasket Set Guko from EPDM

conical rubber gaskets, for filtering flasks

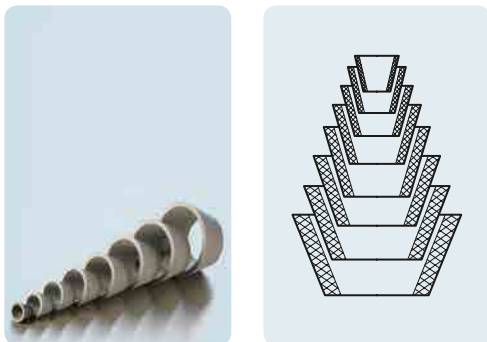

Cat. No.	Description	Pack Unit
29 202 00 01	8 Guko gaskets, size 22 to 84	1



Cat. No.	d ₁ (OD) (mm)	d ₂ (OD) (mm)	h (mm)	s (mm)	Pack Unit
29 202 12 03	22	12	18	2.5	10
29 202 17 09	29	16	23	3.5	10
29 202 23 02	36	22	25	3.5	10
29 202 27 05	44	27	30	4	10
29 202 32 04	53	33	35	4.5	10
29 202 36 07	63	43	35	5	10
29 202 39 07	73	52	37	5	10
29 202 43 03	84	61	40	5.5	10

Rubber Conical Gaskets Guko

from EPDM, for filtering flasks

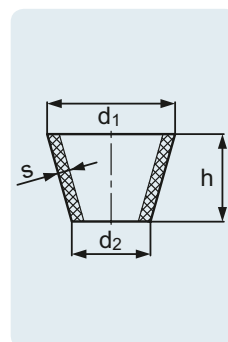

From DURAN® glass with its good thermal shock and chemical resistance. Filter funnels mate to the filtering flask via a conical rubber seal (GUKO).

Typical applications: qualitative inorganic analysis and preparative chemistry.

Cat. No.	Porosity	d ₁ (OD) (mm)	h (mm)	OD (mm)	Disc Ø (mm)	Pack Unit
Capacity: 50 mL						
25 852 01 01	1	10	130	40	35	1
25 852 02 04	2	10	130	40	35	1
25 852 03 07	3	10	130	40	35	1
25 852 04 01	4	10	130	40	35	1
25 852 05 04	5	10	130	40	35	1
Capacity: 75 mL						
25 852 11 06	1	10	132	56	45	1
25 852 12 09	2	10	132	56	45	1
25 852 13 03	3	10	132	56	45	1
25 852 14 06	4	10	132	56	45	1
25 852 15 09	5	10	132	56	45	1
Capacity: 125 mL						
25 852 21 02	1	10	140	72	60	1
25 852 22 05	2	10	140	72	60	1
25 852 23 08	3	10	140	72	60	1
25 852 24 02	4	10	140	72	60	1
25 852 25 05	5	10	140	72	60	1
Capacity: 500 mL						
25 852 31 07	1	22	240	107	95	1
25 852 32 01	2	22	240	107	95	1
25 852 33 04	3	22	240	107	95	1
25 852 34 07	4	22	240	107	95	1
25 852 35 01	5	22	240	107	95	1
Capacity: 1000 mL						
25 852 41 03	1	22	270	136	120	1
25 852 42 06	2	22	270	136	120	1
25 852 43 09	3	22	270	136	120	1
25 852 44 03	4	22	270	136	120	1
25 852 45 06	5	22	270	136	120	1
Capacity: 4 000 mL						
25 852 61 04	1	30	425	202	175	1
25 852 62 07	2	30	425	202	175	1
25 852 63 01	3	30	425	202	175	1
25 852 64 04	4	30	425	202	175	1

DURAN® Filter Funnel

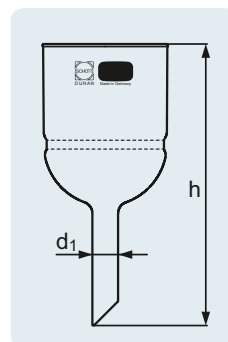

DURAN® Buechner Funnel

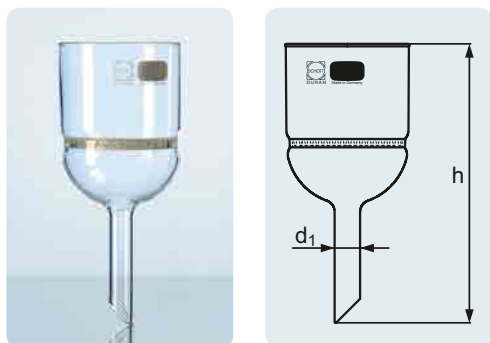

From DURAN® glass with its good thermal shock and chemical resistance. The Buechner funnel features a glass support for membrane and paper filters.

Cat. No.	Capacity (mL)	d ₁ (OD) (mm)	h (mm)	OD (mm)	Matching filter paper Ø (mm)	Disc Ø (mm)	Pack Unit
21 341 22 07	70	10	132	57	45	48	1
21 341 28 07	125	10	140	72	55	60	1
21 341 34 09	220	18	190	90	70	73	1
21 341 44 05	500	22	240	106	90	95	1
21 341 54 01	1000	22	270	136	110	120	1

DURAN® Filter Crucible

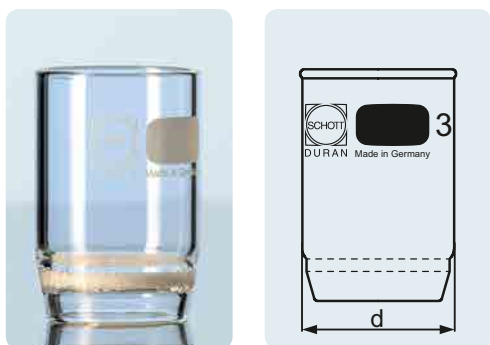

From DURAN® glass with its good thermal shock and chemical resistance.

Cat. No.	Porosity	d (OD) (mm)	Remark	Pack Unit
Capacity: 8 mL				
25 851 02 03	2	24	suitable rubber sleeve cat. no. 29 201 14 08; suitable filter adapter cat. no. 24 316 16 04	10
25 851 03 06	3	24	suitable rubber sleeve cat. no. 29 201 14 08; suitable filter adapter cat. no. 24 316 16 04	10
25 851 04 09	4	24	suitable rubber sleeve cat. no. 29 201 14 08; suitable filter adapter cat. no. 24 316 16 04	10
Capacity: 15 mL				
25 851 11 05	1	28	suitable rubber sleeve cat. no. 29 201 21 04; suitable filter adapter cat. no. 24 316 22 06	10
25 851 12 08	2	28	suitable rubber sleeve cat. no. 29 201 21 04; suitable filter adapter cat. no. 24 316 22 06	10
25 851 13 02	3	28	suitable rubber sleeve cat. no. 29 201 21 04; suitable filter adapter cat. no. 24 316 22 06	10
25 851 14 05	4	28	suitable rubber sleeve cat. no. 29 201 21 04; suitable filter adapter cat. no. 24 316 22 06	10
Capacity: 30 mL				
25 851 21 01	1	36	suitable rubber sleeve cat. no. 29 201 26 01; suitable filter adapter cat. no. 24 316 26 09	10
25 851 22 04	2	36	suitable rubber sleeve cat. no. 29 201 26 01; suitable filter adapter cat. no. 24 316 26 09	10
25 851 23 07	3	36	suitable rubber sleeve cat. no. 29 201 26 01; suitable filter adapter cat. no. 24 316 26 09	10
25 851 24 01	4	36	suitable rubber sleeve cat. no. 29 201 26 01; suitable filter adapter cat. no. 24 316 26 09	10
25 851 25 04	5	36	suitable rubber sleeve cat. no. 29 201 26 01; suitable filter adapter cat. no. 24 316 26 09	10
Capacity: 50 mL				
25 851 31 06	1	46	suitable rubber sleeve cat. no. 29 201 31 09; suitable filter adapter cat. no. 24 316 32 02	10
25 851 32 09	2	46	suitable rubber sleeve cat. no. 29 201 31 09; suitable filter adapter cat. no. 24 316 32 02	10
25 851 33 03	3	46	suitable rubber sleeve cat. no. 29 201 31 09; suitable filter adapter cat. no. 24 316 32 02	10
25 851 34 06	4	46	suitable rubber sleeve cat. no. 29 201 31 09; suitable filter adapter cat. no. 24 316 32 02	10
25 851 35 09	5	46	suitable rubber sleeve cat. no. 29 201 31 09; suitable filter adapter cat. no. 24 316 32 02	10

Cat. No.	d (OD) (mm)	Remark	Pack Unit
29 201 14 08	26	suitable filter adapter cat. no. 24 316 16 04	10
29 201 21 04	33	suitable filter adapter cat. no. 24 316 22 06	10
29 201 26 01	41	suitable filter adapter cat. no. 24 316 26 09	10
29 201 31 09	49	suitable filter adapter cat. no. 24 316 32 02	10

Rubber Adaptor

from EPDM, for filter crucibles

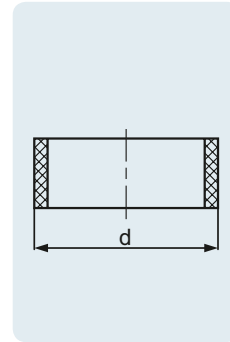

A
121 °C

Tmax.
150 °C

Cat. No.	d (OD) (mm)	d ₁ (OD) (mm)	h (mm)	Remark	Pack Unit
24 316 16 04	27	10	108	suitable rubber sleeve cat. no. 29 201 14 08	10
24 316 22 06	34	10	110	suitable rubber sleeve cat. no. 29 201 21 04	10
24 316 26 09	41	10	125	suitable rubber sleeve cat. no. 29 201 26 01	10
24 316 32 02	50	10	132	suitable rubber sleeve cat. no. 29 201 31 09	10

DURAN® Filter Crucible / Funnel Adapter

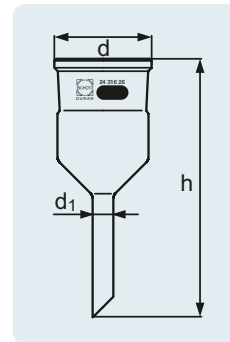

A
121 °C

USP
Standard

Interchangeable filter disks. Available in three filter diameters, each of which are available in four different porosities. Important: Seal the filter disk between two FKM seals. After filtration, disk can be removed to allow simple and safe removal of the filtrand. Long filter disk service life, as disks are not damaged when the filtrand is scraped off. Easy cleaning of both sides is possible. Cost-effective as components and disks can be ordered separately as required.

Cat. No.	Description	Capacity (mL)	Thread	Disc Ø (mm)	Pack Unit
24 720 24 07		30	28	24	1
24 720 50 01		250	54	50	1
24 720 90 03		1 000	95	90	1
Suitable slit sieves as support for membrane and paper filters for Cat. No. 24 720 50 01					
21 340 31 08	DURAN® slit sieve disc, diameter 48 mm				10

DURAN® Filter Funnel Head

with PP funnel, and two FKM seals

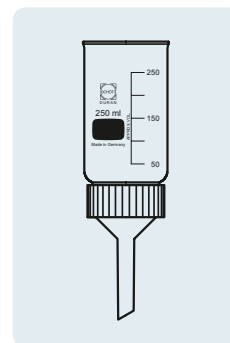

A
121 °C

Tmax.
140 °C

DURAN® Filter Head

threaded

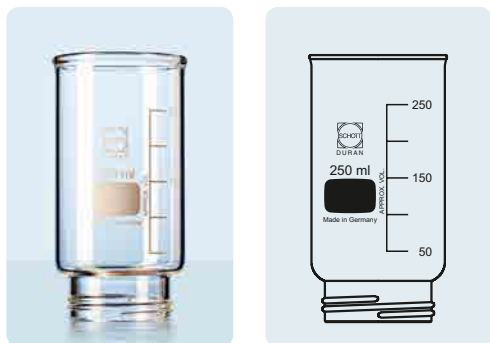

A
121 °C

USP
Standard

Cat. No.	Capacity (mL)	Thread	Pack Unit
24 721 24 08	30	28	1
24 721 50 02	250	54	1
24 721 90 04	1 000	95	1

DURAN® Filter Disk

with fused glass rim



A
121 °C

USP
Standard

Tmax.
450 °C

From DURAN® glass with its good thermal shock and chemical resistance. Fused glass rim.

Cat. No.	Porosity	Pack Unit
Plate: $\varnothing = 24$ mm		
25 202 41 04	1	1
25 202 42 07	2	1
25 202 43 01	3	1
25 202 44 04	4	1
Plate: $\varnothing = 50$ mm		
25 205 01 05	1	1
25 205 02 08	2	1
25 205 03 02	3	1
25 205 04 05	4	1
Plate: $\varnothing = 90$ mm		
25 209 01 09	1	1
25 209 02 03	2	1
25 209 03 06	3	1
25 209 04 09	4	1

FKM Seals for Filter Disks

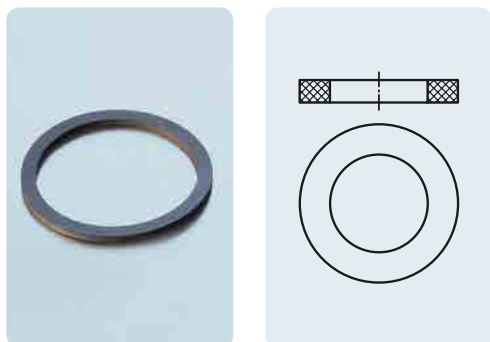

A
121 °C

Tmax.
200 °C

Cat. No.	Disc \varnothing (mm)	Pack Unit
29 220 24 08	24	10
29 220 50 02	50	10
29 220 90 04	90	10

Cat. No.	Thread	d (OD) (mm)	Pack Unit
29 221 24 09	28	10	1
29 221 50 03	54	12	1
29 221 90 05	95	18	1

Funnel for Filter Funnel Head

from PP

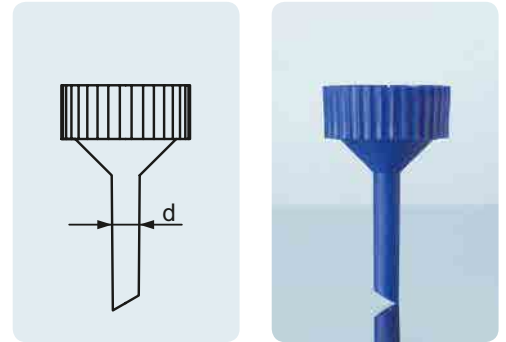

Typical application: in-line filtration of gas lines to remove solid impurities (e.g. dust).

DURAN® Pipeline Filter

Cat. No.	d ₁ (OD) (mm)	Porosity	Pack Unit
Plate: Ø = 30 mm			
25 855 01 04	10	1	1
25 855 02 07	10	2	1
25 855 03 01	10	3	1
25 855 04 04	10	4	1
Plate: Ø = 60 mm			
25 855 11 09	16	1	1
25 855 12 03	16	2	1
25 855 13 06	16	3	1
25 855 14 09	16	4	1
Plate: Ø = 90 mm			
25 855 21 05	16	1	1
25 855 22 08	16	2	1
25 855 23 02	16	3	1
25 855 24 05	16	4	1

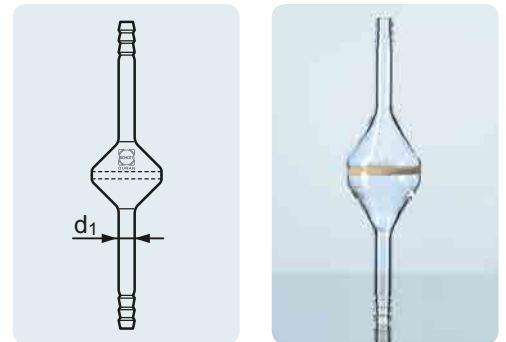

Typical application: extraction of clear filtrate (not the filtrand).

DURAN® Immersion Filter

for reverse filtration

Cat. No.	d ₁ (OD) (mm)	h (mm)	Porosity	Disc Ø (mm)	Pack Unit
25 855 61 07	10	210	1	35	1
25 855 62 01	10	210	2	35	1
25 855 63 04	10	210	3	35	1
25 855 64 07	10	210	4	35	1

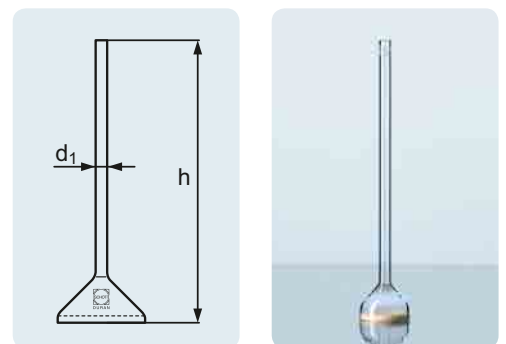

DURAN® Gas Distribution Tube

Typical application: reactions between gases and liquids.

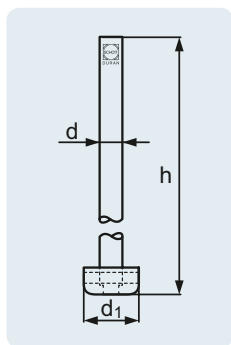

Cat. No.	d (OD) (mm)	d ₁ (OD) (mm)	h (mm)	Porosity	Pack Unit
side mounted filter cup					
25 856 00 02	6	22	250	0	5
25 856 01 05	6	22	250	1	5
25 856 02 08	6	22	250	2	5
centrally mounted filter cup					
25 856 10 07	11	34	250	1	5
25 856 11 01	9	25	250	1	5
25 856 12 04	9	25	250	2	5
25 856 21 06	11	34	250	1	5



DURAN® Gas Washing Bottle

With screw-connection system. The insertion height of the head is adjustable. Individual parts can also be ordered separately.

Drechsel type head

Typical applications: cleaning ("washing") of gases with solvents.

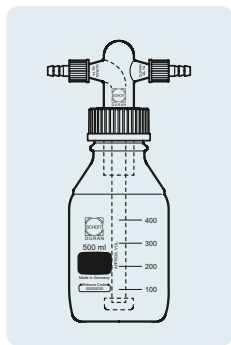

Cat. No.	Capacity (mL)	DIN Thread (GL)	Porosity	Hose connection d (OD) (mm)	Bowl (mm)	Pack Unit
without filter disk						
24 713 00 08	500	45		9		1
with filter disk						
25 704 01 01	500	45	1	9	25	1



Cat. No.	Description	Pack Unit
Individual parts		
24 713 02 05	Drechsel-head, without filter disc	1
25 754 01 09	Drechsel-head, with filter disc (Por. 1)	1
21 801 44 01	DURAN® Laboratory bottle 500 mL, with DIN thread GL 45	10
29 255 06 03	Plastic hose connection, straight	10
29 227 05 08	Screw-caps with aperture, PBT, GL 14	10
29 227 10 07	Screw-caps with aperture, PBT, GL 45	10
29 228 25 01	VQM rubber ring (26 x 42 x 5 mm)	10

DURAN® Gas Washing Bottle

Typical applications: cleaning ("washing") of gases with solvents.

head with filter disk, with standard ground joint

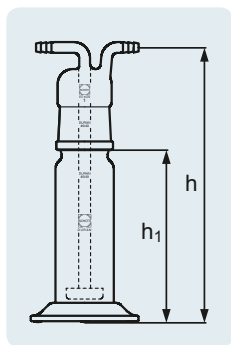

Cat. No.	Description	Capacity (mL)	h (mm)	h ₁ (mm)	Neck	Porosity	Hose connection d (OD) (mm)	Bowl (mm)	Pack Unit
25 701 01 07		100	250	180	34/35	1	10	25	1
25 702 01 08		250	250	160	45/40	1	10	34	1
Individual parts									
25 752 01 07	Gas washing bottle, head with fritted disc (100 mL)					1			1
25 752 01 08	Gas washing bottle, head with fritted disc (250 mL)					1			1



Typical application: cleaning ("washing") of gases with solvents.

Cat. No.	Capacity (mL)	d (OD) (mm)	h (mm)	h ₁ (mm)	Neck	Porosity	Hose connection d (OD) (mm)	Pack Unit
25 703 01 09	350	60	250	180	29/32	1	10	1

DURAN® Gas Washing Bottle

with fused-in filter disk, with standard ground joint and cap

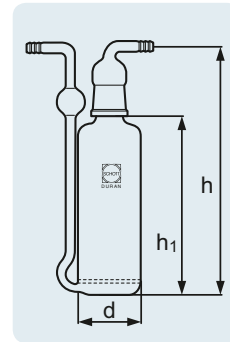

Typical application: extraction of clear filtrate (not the filtrand).

Cat. No.	d (OD) (mm)	d ₁ (OD) (mm)	h (mm)	Porosity	Pack Unit
25 857 11 02	6	10	100	1	10
25 857 12 05	6	10	100	2	10
25 857 13 08	6	10	100	3	10
25 857 14 02	6	10	100	4	10

DURAN® Micro Immersion Filter

for reverse filtration

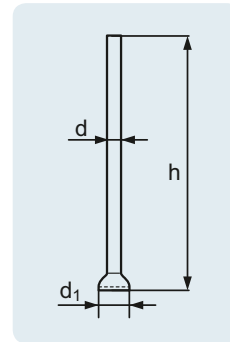

Cat. No.	d (OD) (mm)	h (mm)	Porosity	Pack Unit
25 857 20 04	13	25	0	10
25 857 21 07	13	25	1	10
25 857 22 01	13	25	2	10
25 857 23 04	13	25	3	10
25 857 24 07	13	25	4	10

DURAN® Micro Filter Candle

without tube

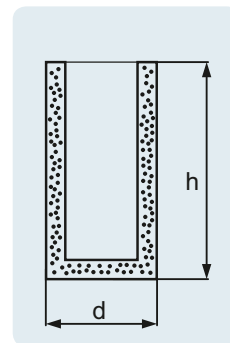

DURAN® Micro Filter Candle

with narrow tube

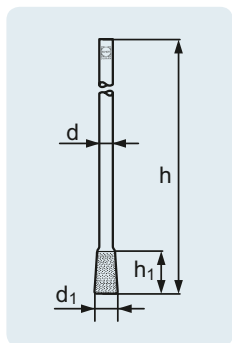

Cat. No.	d (OD) (mm)	h (mm)	Porosity	Cartridge d ₁ (OD) (mm)	Cartridge h ₁ (mm)	Pack Unit
25 857 30 09	8	200	0	13	25	10
25 857 31 03	8	200	1	13	25	10
25 857 32 06	8	200	2	13	25	10
25 857 33 09	8	200	3	13	25	10
25 857 34 03	8	200	4	13	25	10



DURAN® Micro Filter Funnel

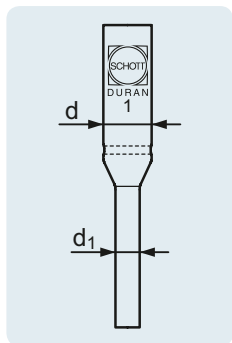

Cat. No.	Capacity (mL)	d (OD) (mm)	d ₁ (OD) (mm)	Porosity	Pack Unit
25 857 51 04	2	10	6	1	10
25 857 52 07	2	10	6	2	10
25 857 53 01	2	10	6	3	10
25 857 54 04	2	10	6	4	10



DURAN® Micro Filter Funnel

Pregl type

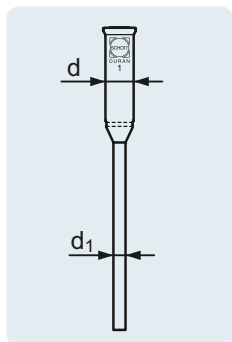
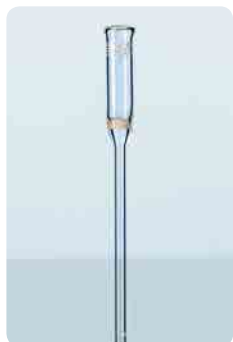

Cat. No.	Capacity (mL)	d (OD) (mm)	d ₁ (OD) (mm)	Porosity	Pack Unit
25 857 61 09	4	10	6	1	10



Cat. No.	Capacity (mL)	d (OD) (mm)	d ₁ (OD) (mm)	Porosity	Pack Unit
25 853 21 03	30	20	9	1	10
25 853 22 06	30	20	9	2	10
25 853 23 09	30	20	9	3	10
25 853 24 03	30	20	9	4	10

DURAN® Filter Tube

Allihn type

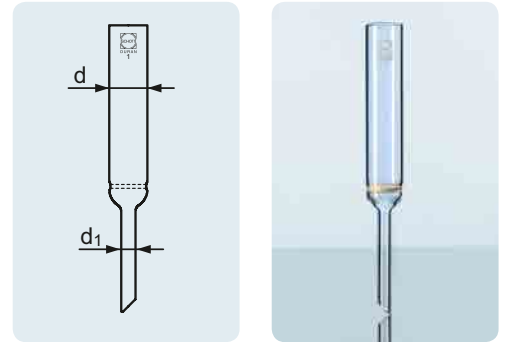

Particular suited for use with hot or aggressive chemicals thanks to the excellent thermal shock and chemical resistance of DURAN®.

Typical applications: decanting and filtration of liquids.

DURAN® Funnel

with short stem

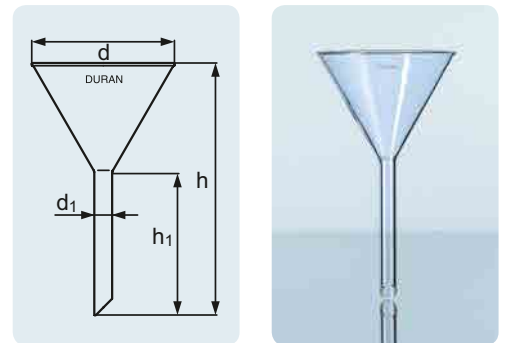

Cat. No.	d (OD) (mm)	d ₁ (OD) (mm)	h (mm)	h ₁ (mm)	Matching filter paper Ø (mm)	Remark	Pack Unit
21 351 23 08	35	6	60	35	45 – 55		10
21 351 28 05	45	6	80	45	55 – 70	Non-DIN ISO size.	10
21 351 33 04	55	8	95	55	70 – 90		10
21 351 38 01	70	8	125	70	110 – 125	Non-DIN ISO size.	10
21 351 41 03	80	10	140	80	125 – 150	Non-DIN ISO size.	10
21 351 46 09	100	10	180	100	150 – 185		10
21 351 51 08	120	16	210	120	185 – 240	Non-DIN ISO size.	10
21 351 57 08	150	16	265	150	240 – 270		10
21 351 59 05	180	20	290	150	270 – 320	Non-DIN ISO size.	1
21 351 61 04	200	26	325	175	320 – 385	Non-DIN ISO size.	1
21 351 66 01	250	30	370	175	385 – 400	Non-DIN ISO size.	1
21 351 69 01	300	30	409	175	500	Non-DIN ISO size.	1

From DURAN® glass with its good thermal shock and chemical resistance.

Typical applications: decanting of powdered substances and granulated material.

DURAN® Powder Funnel

with short, wide stem

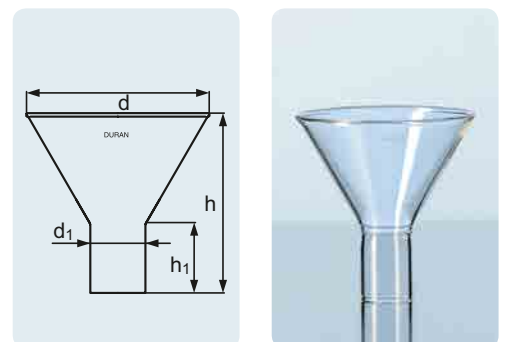

Cat. No.	d (OD) (mm)	d ₁ (OD) (mm)	h (mm)	h ₁ (mm)	Pack Unit
DURAN®					
21 354 33 07	55	20	60	30	10
21 354 38 04	70	22	72	30	10
21 354 41 06	80	24	79	30	10
21 354 46 03	100	26	94	30	10
21 354 51 02	120	34	105	30	10
21 354 55 05	160	35	140	30	1
21 354 61 07	200	40	170	30	1

DURAN® Funnel

with long stem, Bunsen funnel

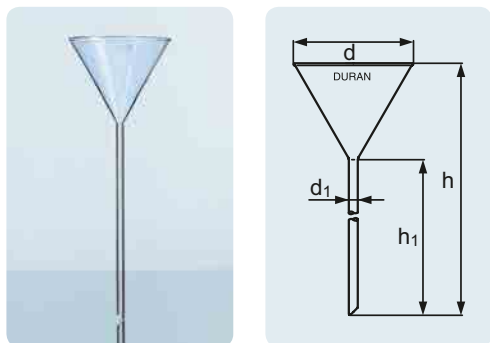

DIN ISO
4798

A
121 °C

USP
Standard

From DURAN® glass with its good thermal shock and chemical resistance.

Typical applications: filtering and decanting of liquids of different densities.

Cat. No.	d (OD) (mm)	d ₁ (OD) (mm)	h (mm)	h ₁ (mm)	Matching filter paper Ø (mm)	Remark	Pack Unit
21 353 33 06	55	6	190	150	70 – 90		10
21 353 38 03	70	6	200	150	110 – 125	Non-DIN ISO size.	10
21 353 41 05	80	6	210	150	125 – 150	Non-DIN ISO size.	10

DURAN® Analytical Funnel

for quick filtration

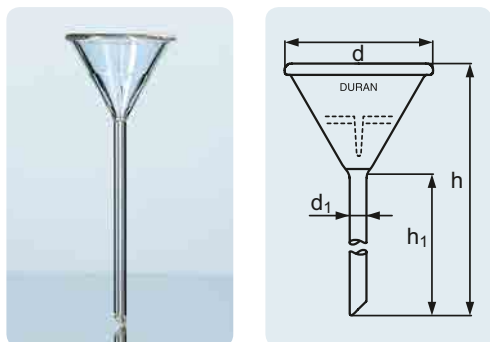

A
121 °C

USP
Standard

From DURAN® glass with its good thermal shock and chemical resistance.

Typical application: for rapid liquid filtration.

Cat. No.	d (OD) (mm)	d ₁ (OD) (mm)	h (mm)	h ₁ (mm)	Matching filter paper Ø (mm)	Pack Unit
21 331 37 02	65	9	200	150	70 – 90	10
21 331 41 07	80	9	210	150	110 – 125	10
21 331 48 01	110	9	265	180	150 – 185	10

From DURAN® glass with its good thermal shock and chemical resistance. The ribbed form is ideal for filtering with round-paper.

Typical application: filtering of liquids.

Cat. No.	d (OD) (mm)	d ₁ (OD) (mm)	h (mm)	h ₁ (mm)	Matching filter paper Ø (mm)	Pack Unit
21 352 38 02	70	8	125	70	110 – 125	10
21 352 41 04	80	10	140	80	125 – 150	10
21 352 46 01	100	10	180	100	150 – 185	10
21 352 57 09	150	16	266	150	240 – 270	10
21 352 61 05	200	26	326	175	320 – 385	1

DURAN® Funnel

ribbed

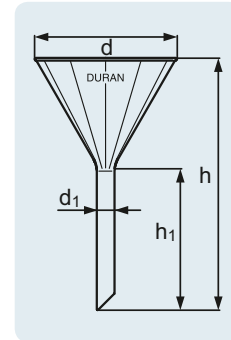

Made from DURAN® glass with its good thermal shock and chemical resistance. Filter funnels mate to the filtering flask via a conical rubber seal (GUKO).

Typical application: filtering of liquids.

Cat. No.	Capacity (mL)	d (OD) (mm)	d ₁ (OD) (mm)	d ₂ (OD) (mm)	h (mm)	Porosity	Pack Unit
25 854 03 09	25	55	25	8	100	3	1
25 854 04 03	25	55	25	8	100	4	1

DURAN® Filter Funnel

conical shape

