

07

GLASSWARE FOR
MICROBIOLOGY



GLASSWARE FOR MICROBIOLOGY

Due to its high thermal-shock resistance, DURAN® microbiology glassware is ideal for auto-claving and sterilisation processes and shows, even after multiple use no signs of wear. Unlike plastic items, it is very resistant to mechanical wear even after repeated use and sterilisation cycles.

Due to the nearly inert behaviour, there are no interactions (e.g. ion exchange) between medium and glass and any spurious influence on experiments is thereby effectively excluded.

DURAN® products are completely transparent in visible light and unlike many plastic products are ideal for use under the microscope.

DUROPLAN® Petri dishes offer outstanding performance due to their distortion-free transparency and high planarity (flatness). These excellent geometrical properties enable uniform agar distribution and reproducible culture growth.

Alongside the Petri dishes, the DURAN® range includes a wide range of culture bottles, culture flasks, roller bottles and spot plates.

In addition, there are various types of staining dishes.

Usage tips:

- Only autoclave products that are free from damage such as scratches, cracks or nicks.
- The outstanding thermal properties (max. operating temperature of +500 °C, thermal shock resistance $\Delta T = 100$ K) enable high temperature processes, such as hot air sterilisation.

07



> Find your nearest **distributor** on our global network:
www.DWK-LifeSciences.com/DURAN/distributors

Baffled flasks disrupt the circular laminar flow and cause additional turbulence. The baffles increase the gas exchange surface area of the liquid, and the oxygen uptake.

Cat. No.	Capacity (mL)	d (OD) (mm)	h (mm)	DIN Thread (GL)	Pack Unit
with membrane screw cap and pouring ring					
21 283 36 55	250	85	145	45	4
21 283 44 54	500	105	180	45	4
21 283 54 59	1 000	135	221	45	1
without membrane screw cap and pouring ring					
21 283 54 01	1 000	135	221	45	1
21 283 36 06	250	85	145	45	4
21 283 44 05	500	105	180	45	4

DURAN® Baffled Flask

with GL 45 thread

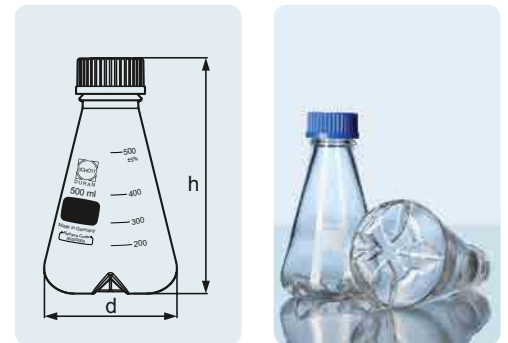

These Petri dishes are made from DURAN® borosilicate 3.3 glass using a special manufacturing process that permits the uniform distribution of agar and guarantees distortion-free observation.

Typical applications: biological and clinical research, cultivation of microorganism, microscopy.

Cat. No.	d ₁ (OD) (mm)	d ₂ (OD) (mm)	h (mm)	h ₁ (mm)	Pack Unit
21 755 41 01	60	54	22	20	10
21 755 43 07	80	74	22	20	10
21 755 46 07	100	94	17	15	10
21 755 48 04	100	94	22	20	10
21 755 51 06	120	114	22	20	10
21 755 53 03	150	143	32	30	10

DUROPLAN® Petri Dish

lid and base have planar surfaces, and free from bubbles and streaks

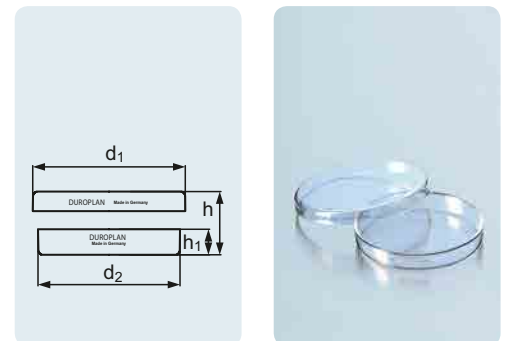

Cat. No.	d (OD) (mm)	h (mm)	Pack Unit
23 755 39 03	40	12	10
23 755 40 08	60	15	10
23 755 42 05	80	15	10
11 840 71	90	15	10
23 755 45 05	100	10	10
23 755 46 08	100	15	10
23 755 48 05	100	20	10
23 755 51 07	120	20	10
23 755 52 01	150	25	10
23 755 56 04	180	30	10
23 755 59 04	200	30	10
23 755 61 03	200	45	10

STERIPLAN® Petri Dish

from Soda-lime Glass

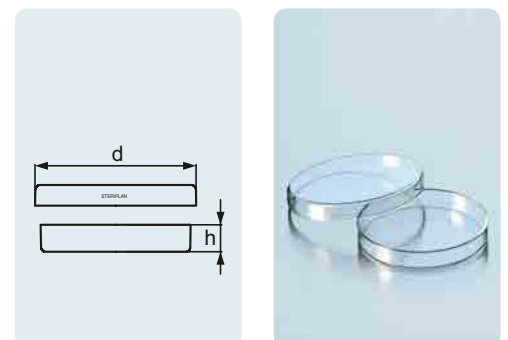

DURAN® Petri Dish

pressed

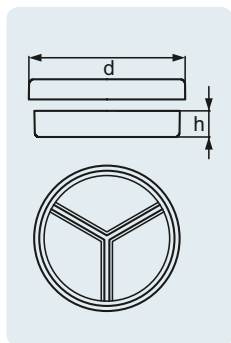

Bottom of the base has three knobs for stability.

Typical applications: biological and clinical work, preparation of agars, microscopy.

Cat. No.	d (OD) (mm)	h (mm)	Pack Unit
without sections			
21 754 46 06	100	15	10
21 754 48 03	100	20	10
Half-sectional			
21 750 48 08	100	20	10
Three-sectional			
21 753 48 02	100	20	10
Four-sectional			
21 752 48 01	100	20	10

Spot Plate Type Feigl

from Soda-lime Glass

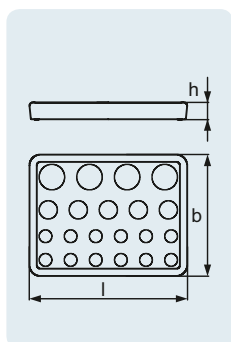

Typical application: observation of reactions and colour changes.

Cat. No.	h (mm)	l (mm)	b (mm)	Pack Unit
23 671 52 08	14	130	100	10

DURAN® Centrifuge Tube

with round bottom

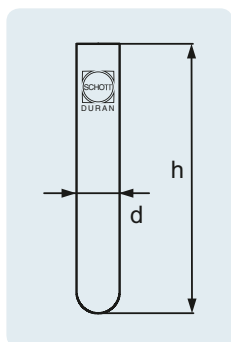

Centrifuge tubes are very resistant to mechanical loading. The higher density fraction collects in the bottom. Consequently solids can be collected and separated.

Cat. No.	d (OD) (mm)	h (mm)	Nominal capacity (mL)	Remark	Pack Unit
21 601 10 04	12	100	6		50
21 601 11 07	16	100	12		50
21 601 14 07	24	100	25		10
21 601 17 07	34	100	50		10
21 601 24 03	40	115	80	Non-DIN size.	10
21 601 26 09	44	100	80		10
21 601 36 05	56	147	250	Non-DIN size.	10



Centrifuge tubes are very resistant to mechanical loading. The higher density fraction collects in the pointed centre of the bottom. Consequently even small amounts of solids can be collected and separated.

Cat. No.	d (OD) (mm)	h (mm)	Nominal capacity (mL)	Pack Unit
24 263 09 01	16	100	12	50

DURAN® Centrifuge Tube

conical bottom, angle 30°

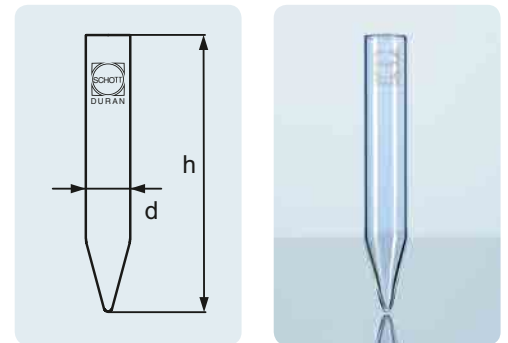

Centrifuge tubes are very resistant to mechanical loading. The higher density fraction collects in the pointed centre of the bottom. Consequently even small amounts of solids can be collected and separated.

Cat. No.	d (OD) (mm)	h (mm)	Nominal capacity (mL)	Pack Unit
21 611 14 05	24	100	25	10
21 611 17 05	34	100	50	10

DURAN® Centrifuge Tube

conical bottom, angle 60°

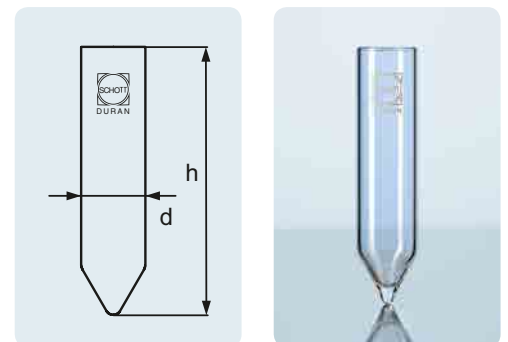

The straight rim permits the use of Kapsenberg caps; tubes are therefore well suited to the culture of micro-organisms (Kapsenberg caps article no. 29 010 09 09 and 29 010 11 08).

Typical applications: growth and storage of sterile cultures.

Cat. No.	d (OD) (mm)	h (mm)	Volume approx. (mL)	Wall thickness (mm)	Pack Unit
26 132 21 08	16	160	20	1.0 – 1.2	100
26 132 23 05	18	180	30	1.0 – 1.2	100

DURAN® Culture Tube

straight rim, for Kapsenberg caps

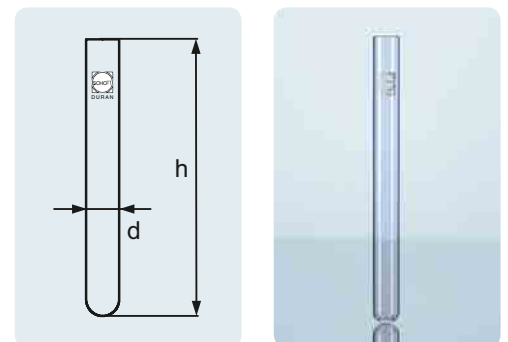

DURAN® Culture Tube

with DIN thread, and screw cap from PBT

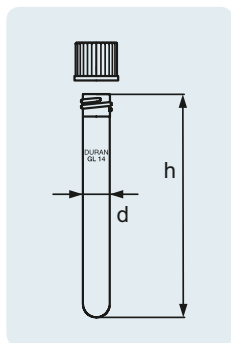

A
121 °C

USP
Standard

The DIN thread permits the use of PBT screw caps; tubes are therefore well suited to the culture of micro-organisms. The contents only come into contact with the glass and PTFE coating of the cap liner.

Typical applications: growing and storage of sterile cultures.

Cat. No.	d (OD) (mm)	h (mm)	DIN Thread (GL)	Volume approx. (mL)	Pack Unit
with screw cap					
26 135 11 55	12	100	14	6	50
26 135 12 58	13	100	14	9	50
26 135 21 51	16	160	18	20	50
26 135 22 54	16	150	18	20	50
26 135 24 51	20	150	18	34	50
26 135 23 57	18	180	18	30	50
without screw cap					
26 135 11 06	12	100	14	6	50
26 135 12 09	13	100	14	9	50
26 135 21 02	16	160	18	20	50
26 135 22 05	16	150	18	20	50
26 135 24 02	20	150	18	34	50
26 135 23 08	18	180	18	30	50

Disposable Culture Tube

from Soda-lime Glass, with DIN thread, and PP screw cap

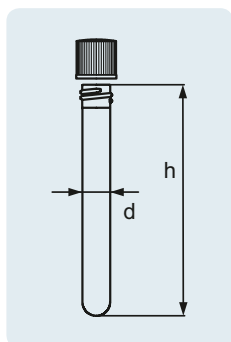

Tmax.
140 °C

Screw cap from PP with cap liner.

Cat. No.	d (OD) (mm)	h (mm)	DIN Thread (GL)	Volume approx. (mL)	Wall thickness (mm)	Pack Unit
with TPE seal						
23 175 11 59	12	100	14	6	1	100
23 175 14 59	16	100	18	12	1	100
23 175 21 55	16	160	18	22	1	100
23 175 23 52	18	180	18	32	1	100

With seal from TPE.

Cat. No.	DIN Thread (GL)	Pack Unit
29 990 12 04	14	100
29 990 13 07	18	100

Screw Cap for Culture Tubes

with seal

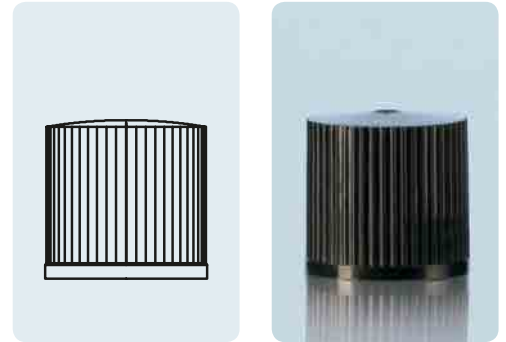

A
121 °C

Tmax.
140 °C

Cat. No.	d (OD) (mm)	h (mm)	Volume approx. (mL)	Wall thickness (mm)	Pack Unit
23 172 01 84	9.75	75	4	0.8	814
23 172 03 65	10.00	75	4	0.6	766
23 172 05 87	11.75	75	5	0.8	550
23 172 08 62	11.75	75	6	0.55	550
23 172 09 65	12.25	75	7	0.55	500
23 172 09 98	12.25	75	6	0.8	500
23 172 07 84	11.75	100	8	0.8	550
23 172 11 97	12.25	100	9	0.8	500
23 172 14 89	15.50	100	14	0.8	310
23 172 10 94	15.75	100	15	0.9	310
23 172 12 83	12.25	120	18	0.8	500
23 172 18 83	10.00	150	8	0.8	766
23 172 19 86	15.50	150	19	0.8	310
23 172 21 93	15.50	160	22	0.8	310

Disposable Culture Tube

from Soda-lime Glass, straight rim

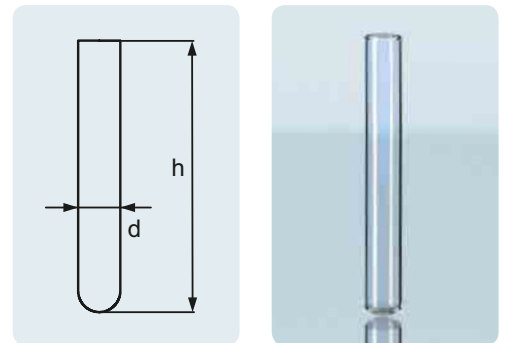

Large, flat, bottom surface allows uniform culture thickness.

Typical application: preparation of cultures in nutrient media.

Cat. No.	Capacity (mL)	d (OD) (mm)	d ₁ (OD) (mm)	h (mm)	Pack Unit
21 501 43 07	450	117	29	100	10

DURAN® Culture Flask Fernbach Type

bulbous shape

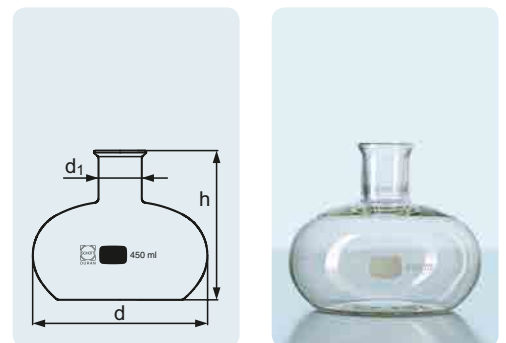

A
121 °C

USP
Standard

DURAN® Culture Flask Fernbach Type

conical shape

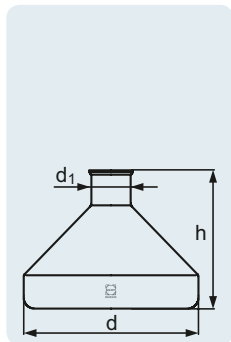

Large, flat, bottom surface allows uniform culture thickness.

Typical application: preparation of cultures in nutrient media.

Cat. No.	Capacity (mL)	d (OD) (mm)	d ₁ (OD) (mm)	h (mm)	Pack Unit
21 511 62 03	1800	200	45	158	2

DURAN® Culture Flask Fernbach Type

conical shape, straight neck for metal caps

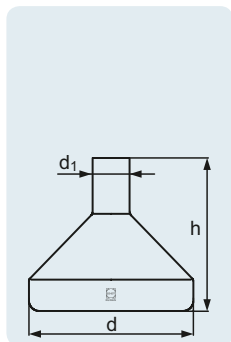

Large, flat, bottom surface allow uniform culture thickness. Compatible metal cap made from either stainless steel (Cat. no. 29 012 24 06) or anodised aluminium (Cat. no. 29 013 24 07) are available.

Typical application: preparation of cultures in nutrient media.

Cat. No.	Capacity (mL)	d (OD) (mm)	d ₁ (OD) (mm)	h (mm)	Pack Unit
21 774 62 09	1800	200	38	175	2

DURAN® Culture Flask Kolle Type

oval neck

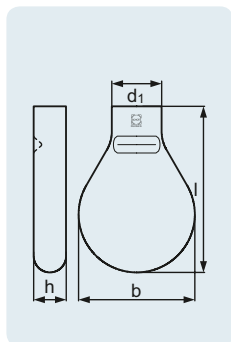

Large, flat, bottom surface allows uniform culture thickness.

Typical application: preparation of cultures in nutrient media.

Cat. No.	Capacity (mL)	d ₁ (OD) (mm)	h (mm)	l (mm)	b (mm)	Pack Unit
21 521 41 06	400	60	39	200	140	10

Large, flat, bottom surface allows uniform culture thickness.

Typical application: preparation of cultures in nutrient media.

Cat. No.	Capacity (mL)	d, (OD) (mm)	h (mm)	l (mm)	b (mm)	Pack Unit
21 541 58 01	1 200	33	56	260	123	10

DURAN® Culture Flask Roux Type

round neck

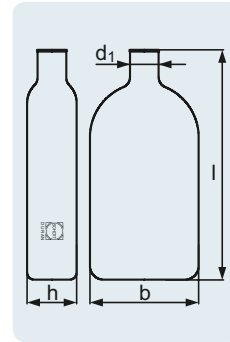

Large, flat, bottom surface allows uniform culture thickness.

Typical application: preparation of cultures in nutrient media.

Cat. No.	Capacity (mL)	h (mm)	l (mm)	b (mm)	Pack Unit
21 571 58 04	1 200	56	275	123	10

DURAN® Culture Flask Roux Type

conical neck, eccentric

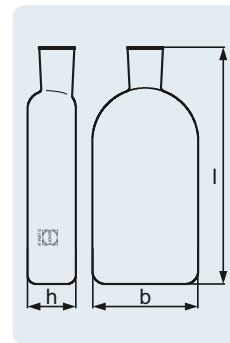

Large, flat bottom surface allows uniform culture thickness.

Typical application: preparation of cultures in nutrient media.

Cat. No.	Capacity (mL)	d (OD) (mm)	h (mm)	l (mm)	b (mm)	Pack Unit
21 551 71 06	4 000	50	90	370	200	1

DURAN® Penicillin Flask

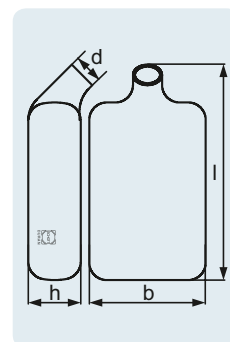

DURAN® Culture Bottle

straight rim, for Kapsenberg caps

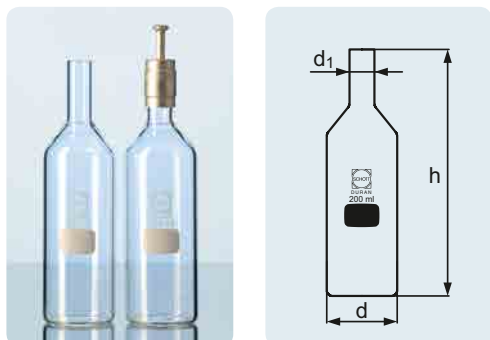

A suitable Kapsenberg cap (cat. no. 29 010 11 08) is available.

Typical application: preparation of cultures in nutrient media.

Cat. No.	Capacity (mL)	d (OD) (mm)	d ₁ (OD) (mm)	h (mm)	Remark	Pack Unit
21 421 17 06	50	40	18	107		10
21 421 24 02	100	40	18	150		10
21 421 32 01	200	50	18	175	DIN 38 411, part 6	10

DURAN® Erlenmeyer Flask

straight rim, for Kapsenberg caps

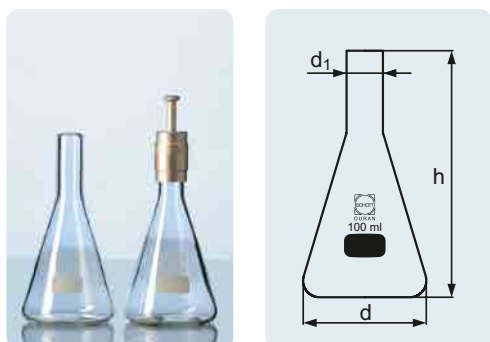

Conical geometry makes the flasks particularly suited for shaking experiments (e.g. media optimisation). A suitable Kapsenberg cap (Cat. no. 29 010 11 08) is available.

Typical application: preparation of cultures in nutrient media.

Cat. No.	Capacity (mL)	d (OD) (mm)	d ₁ (OD) (mm)	h (mm)	Pack Unit
21 491 24 06	100	60	18	120	10

Kapsenberg Cap

from aluminium

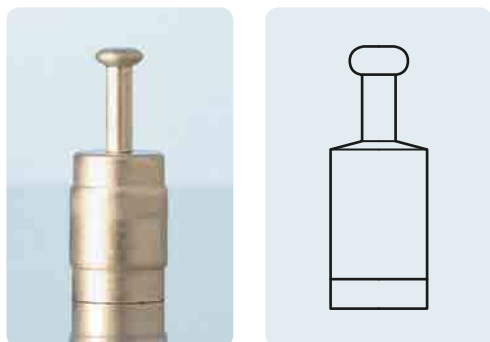

Cat. No.	Description	For neck (mm)	Pack Unit
29 010 09 09	suitable for Culture tubes cat. no. 26 132 21 08	16	10
29 010 11 08	suitable for Culture tubes cat. no. 26 132 23 05, Culture bottle cat. no. 21 421 17 06, 21 421 24 02, 21 421 32 01 and Erlenmeyer tubes cat. no. 21 491 24 06	18	10

Typical application: preparation of cultures in nutrient media.

Cat. No.	Capacity (mL)	d (OD) (mm)	d ₁ (OD) (mm)	h (mm)	Pack Unit
21 431 39 02	300	70	31	168	10
21 431 44 01	500	83	46	204	10
21 431 54 06	1 000	105	46	238	10

DURAN® Culture Media Bottle

straight rim, for use with glass caps

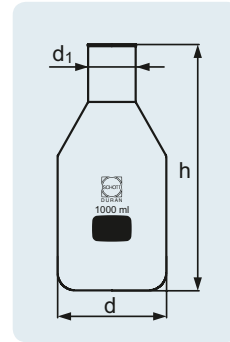

Cat. No.	Description	For neck (mm)	Pack Unit
21 441 18 05	suitable culture media bottle: cat. no. 21 431 39 02	31	10
21 441 29 04	suitable culture media bottle: cat. no. 21 431 44 01 and cat. no. 21 431 54 06	46	10

DURAN® Glass Cap

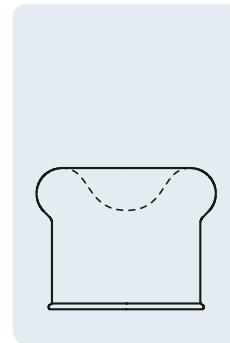

Typical application: preparation of cultures in nutrient media.

Cat. No.	Capacity (mL)	d (OD) (mm)	d ₁ (OD) (mm)	h (mm)	Pack Unit
21 481 31 04	180	48	28	148	10

DURAN® Square Bottle

after Breed-Demeter

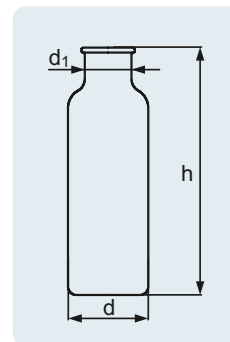

DURAN® Culture Media Bottle

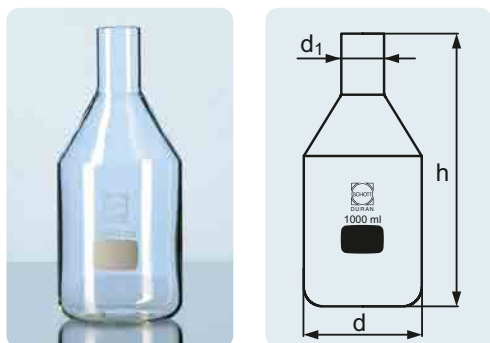

Typical application: preparation of cultures in nutrient media.

Cat. No.	Capacity (mL)	d (OD) (mm)	d ₁ (OD) (mm)	h (mm)	Pack Unit
with beaded rim					
21 451 24 05	100	50	29	115	10
21 451 39 07	300	70	42	168	10
21 451 44 06	500	83	42	207	10
21 451 54 02	1 000	105	46	237	10
21 451 66 04	2 500	150	50	315	1
21 451 73 09	5 000	185	54	390	1
straight neck for metal caps					
21 773 24 03	100	50	38	125	10
21 773 39 05	300	70	38	170	10
21 773 44 04	500	83	38	208	10
21 773 54 09	1 000	105	38	243	10

DURAN® Culture Flask Erlenmeyer Shape

straight neck for metal caps

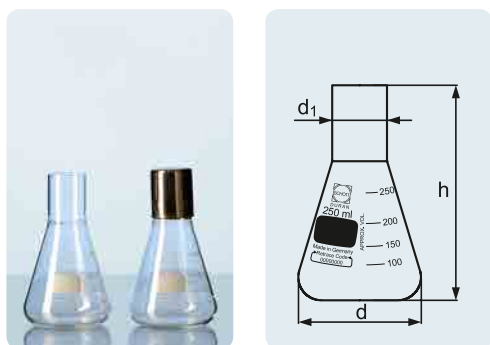

Conical geometry makes the flasks particularly suitable for shaking experiments (e.g. media optimisation). Erlenmeyer flasks with GL screw threads are also available

Typical application: Preparation of cultures in nutrient media.

Cat. No.	Capacity (mL)	d (OD) (mm)	d ₁ (OD) (mm)	h (mm)	Pack Unit
21 771 24 01	100	64	38	114	10
21 771 32 09	200	79	38	138	10
21 771 36 03	250	85	38	149	10
21 771 39 03	300	87	38	161	10
21 771 44 02	500	105	38	183	10
21 771 54 07	1 000	131	38	229	10
21 771 63 09	2 000	166	38	302	10

Metal Cap

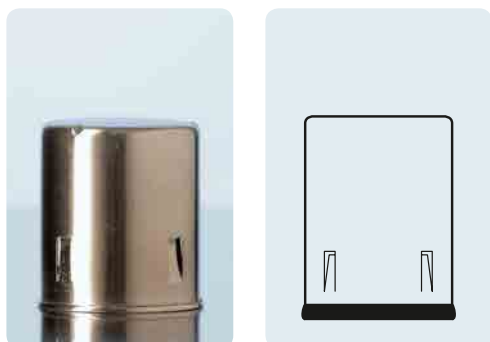

Suitable for: culture flask Cat. No. 21 771 XX XX, Cat. No. 21 774 62 09 and culture media bottle Cat. No. 21 773 XX XX.

Cat. No.	Material	For neck (mm)	Pack Unit
29 012 24 06	Stainless steel	38	10
29 013 24 07	Aluminium, anodised blue	38	10

In addition, the following individual parts are available: porcelain clamp closure (Cat. No. 29 701 08 03), replacement rubber seal (Cat. No. 29 990 31 02) and replacement silicone seal, autoclavable (Cat. No. 29 990 10 07).

Typical applications: sampling and cultivation.

Cat. No.	Capacity (mL)	d (OD) (mm)	d ₁ (OD) (mm)	h (mm)	Pack Unit
without closure					
21 461 24 03	100	45	17	135	10
21 461 36 05	250	57	17	182	10
21 461 44 04	500	74	17	218	10
21 461 54 09	1 000	95	17	265	10

DURAN® Rolled Flange Bottle

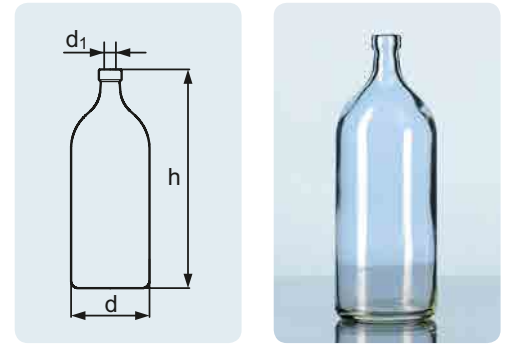

In addition, the following individual parts are available: porcelain clamp closure (Cat. No. 29 701 08 03), replacement rubber seal (Cat. No. 29 990 31 02) and replacement silicone seal, autoclavable (Cat. No. 29 990 10 07).

Typical applications: sampling and cultivation.

Cat. No.	Capacity (mL)	d (OD) (mm)	d ₁ (OD) (mm)	h (mm)	Pack Unit
with clamp closure					
21 465 24 07	100	45	17	135	10
21 465 36 09	250	57	17	182	10
21 465 44 08	500	74	17	218	10
21 465 54 04	1 000	95	17	265	10

DURAN® Rolled Flange Bottle

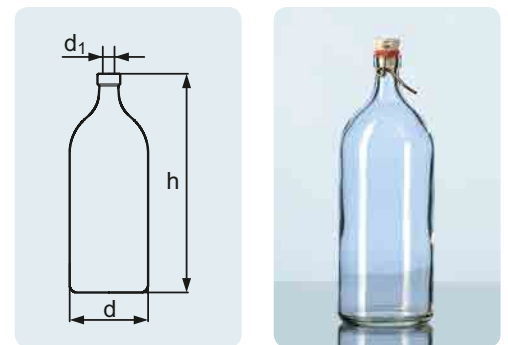

With screw cap and pouring ring (blue, PP).

Typical application: preparation of cultures in nutrient media.

Cat. No.	Capacity (mL)	d (OD) (mm)	h (mm)	Pack Unit
21 772 68 56	2 000	110	285	2
21 772 86 51	3 500	110	450	1

DURAN® Roller Bottle for Cell Cultures

with DIN thread, GL 45

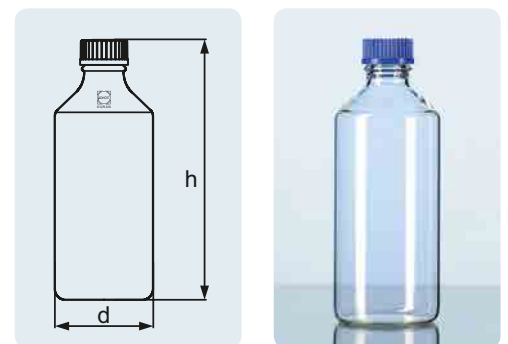

Microscope Slides from Soda-lime Glass

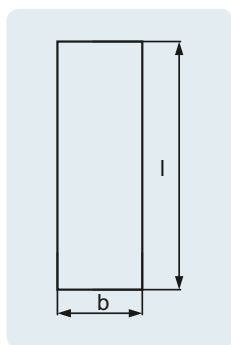

DIN ISO
8037-1

The microscope slides are made from high quality float glass (soda-lime glass) of hydrolytic class 3. Particularly suitable for microscopic examinations. Designed for single use only. Uniform wettability due to flawless surface. It is not necessary to re-adjust the microscope.

Cat. No.	l (mm)	Colour	b (mm)	Pack Unit
with cut edges				
23 550 11 03	76		26	30 x 50
23 550 12 06	76	frosted end	26	30 x 50
ground edges 45°				
23 550 13 09	76		26	30 x 50
23 550 14 03	76	frosted end	26	30 x 50
ground edges 90°				
23 550 22 02	76	blue	26	30 x 50
23 550 21 08	76	white	26	30 x 50
23 550 23 05	76	yellow	26	30 x 50
23 550 24 08	76	white PRINT	26	30 x 50
23 550 25 02	76	white, adhesive with standard coating	26	30 x 50
23 550 26 05	76	white, adhesive ++	26	30 x 50

Cover Slips from D 263® M

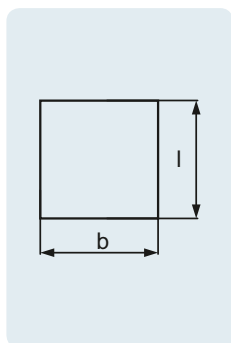

ISO
8255-1

The cover slips are made from pure white borosilicate glass (D 263® M) i.e. absorption-free in the visible spectral range. Cover slips are used as covering material and for fixing preparations during microscopic examinations. They also ensure the distribution of droplets on the microscope slide.

Cat. No.	l (mm)	Wall thickness (mm)	b (mm)	Pack Unit
23 550 31 04	18	#1	18	10 x 100
23 550 32 07	22	#1	22	10 x 100
23 550 33 01	40	#1	24	10 x 100
23 550 34 04	50	#1	24	10 x 100
23 550 35 07	50	#1.5 Automatic machine	24	10 x 100
23 550 36 01	60	#1	24	10 x 100
23 550 37 04	60	#1.5 Automatic machine	24	10 x 100

Staining Jar Coplin Type

from Soda-lime Glass

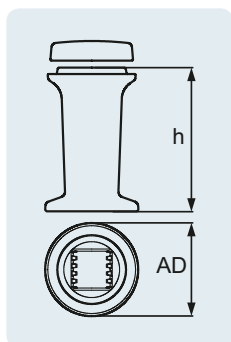

For 10 microscope slides 76 x 26 mm. Note: Do not clean staining dishes and staining jars at temperatures above 60 °C (glass corrosion is possible).

Cat. No.	h (mm)	Outer diameter (AD) (mm)	Pack Unit
23 319 00 06	108	66	10

For 10 microscope slides 76 x 26 mm. Note: Do not clean staining dishes and staining jars at temperatures above 60 °C (glass corrosion is possible).

Cat. No.	h (mm)	l (mm)	b (mm)	Pack Unit
23 314 00 01	90	90	40	10

Staining Dish Hellendahl Type

from Soda-lime Glass, straight sided

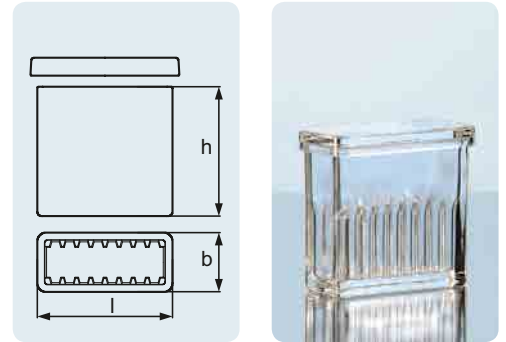

For 16 microscope slides 76 x 26 mm, with widening towards the top. Note: Do not clean staining dishes and staining jars at temperatures above 60 °C (glass corrosion is possible).

Cat. No.	h (mm)	l (mm)	b (mm)	Pack Unit
23 315 00 02	100	60	60	10

Staining Dish Hellendahl Type

from Soda-lime Glass

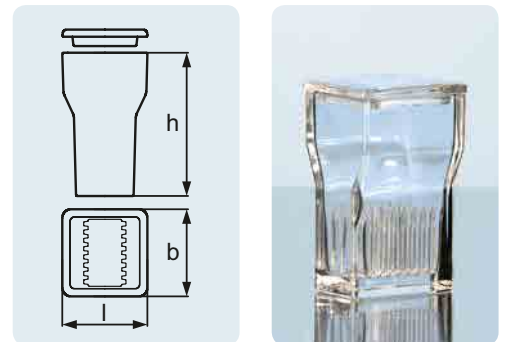

For 10 microscope slides 76 x 26 mm. Note: Do not clean staining dishes and staining jars at temperatures above 60 °C (glass corrosion is possible).

Cat. No.	h (mm)	l (mm)	b (mm)	Pack Unit
23 316 00 03	40	90	70	10

Staining Dish Schiefferdecker Type

from Soda-lime Glass

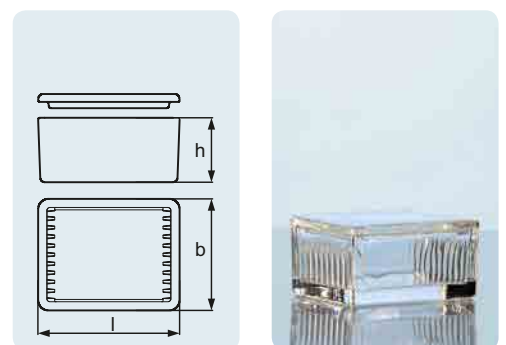

07 GLASSWARE FOR MICROBIOLOGY

Glass Box from Soda-lime Glass

for staining tray 21 317 00 03

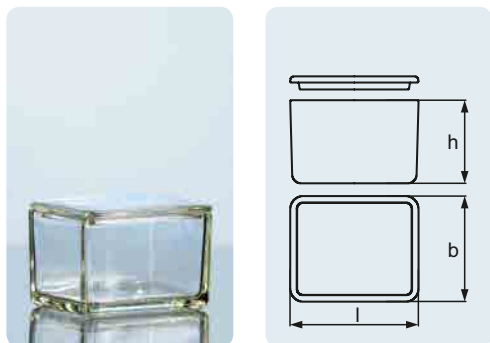

Note: Do not clean staining dishes and staining jars at temperatures above 60 °C (glass corrosion is possible).

Cat. No.	h (mm)	l (mm)	b (mm)	Pack Unit
23 318 00 05	70	108	90	10

DURAN® Staining Tray

For 10 microscope slides 76 x 26 mm or each width up to 52 mm.

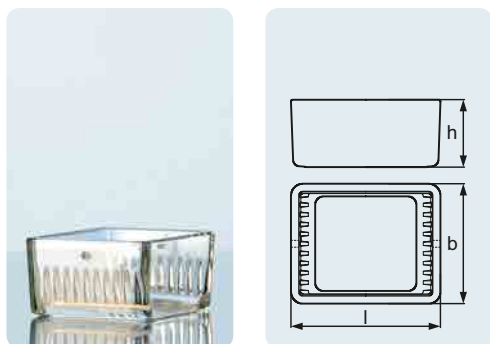

Cat. No.	h (mm)	l (mm)	b (mm)	Pack Unit
21 317 00 03	70	88	40	10



Stainless Steel Handle

for staining tray

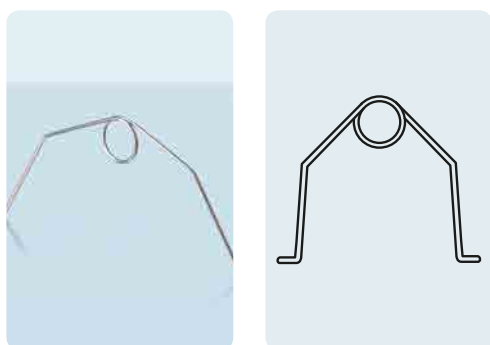

Cat. No.	Pack Unit
29 075 00 02	10